

Фан-флай “Электроманьяк”

Характеристики:

Размах: 800мм

Длина: 814мм

Площадь крыла: 20дм²

Полетный вес: 320-370г

Нагрузка на крыло: 16-18.5г/дм²

Комплектация:

Мотор: 2209

Винт: 10x3.8

Регулятор: 18А

Сервоприводы: НХТ500

Аккумулятор: 850mAh

Материал, если не указано отдельно - потолочная плитка, толщина 3мм.

Разработка: Алексей Юкиш (AlexGold), e-mail: gold333@yandex.ru

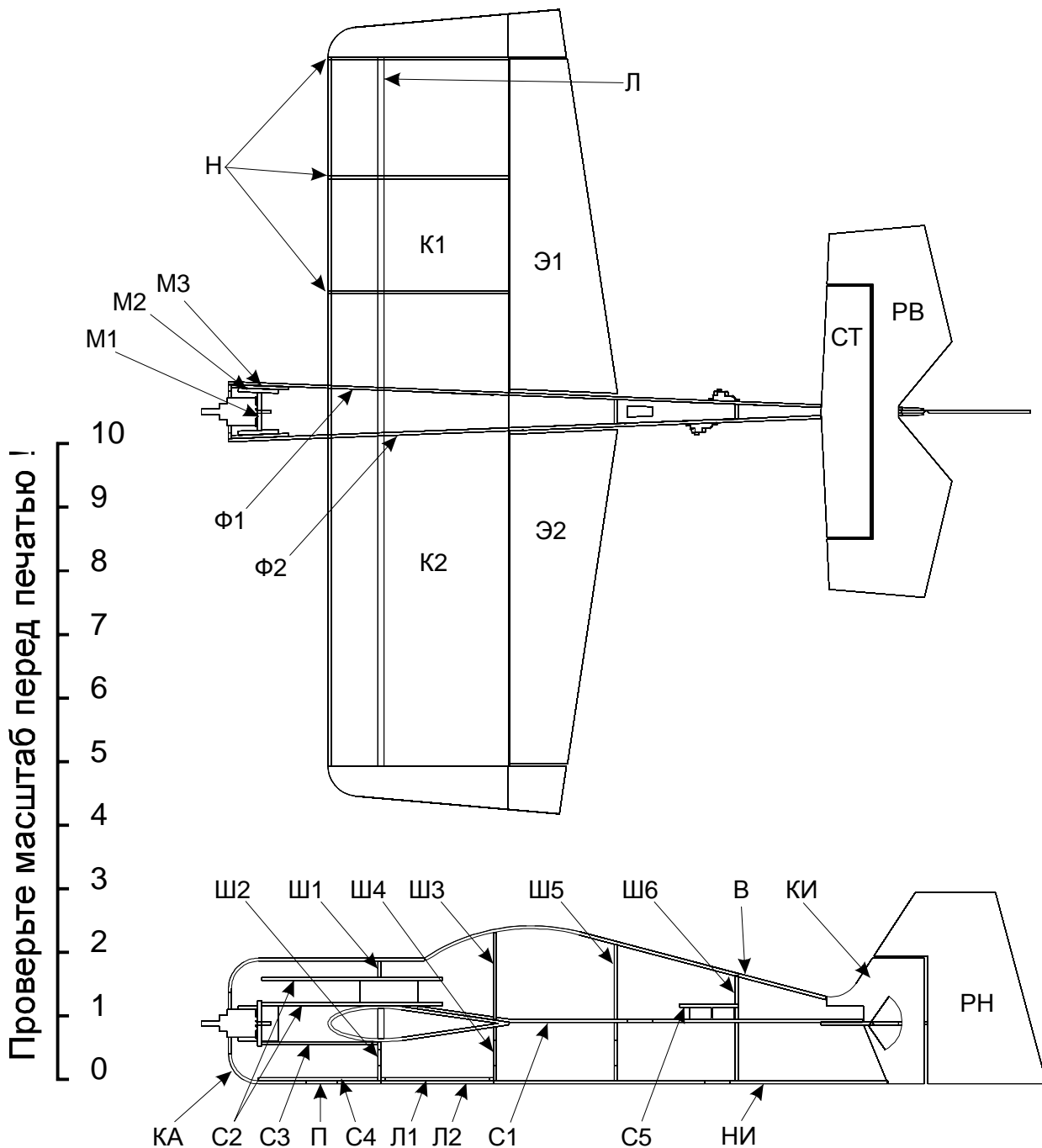

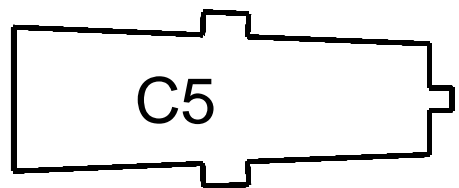
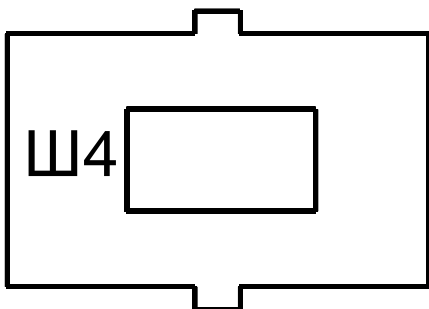
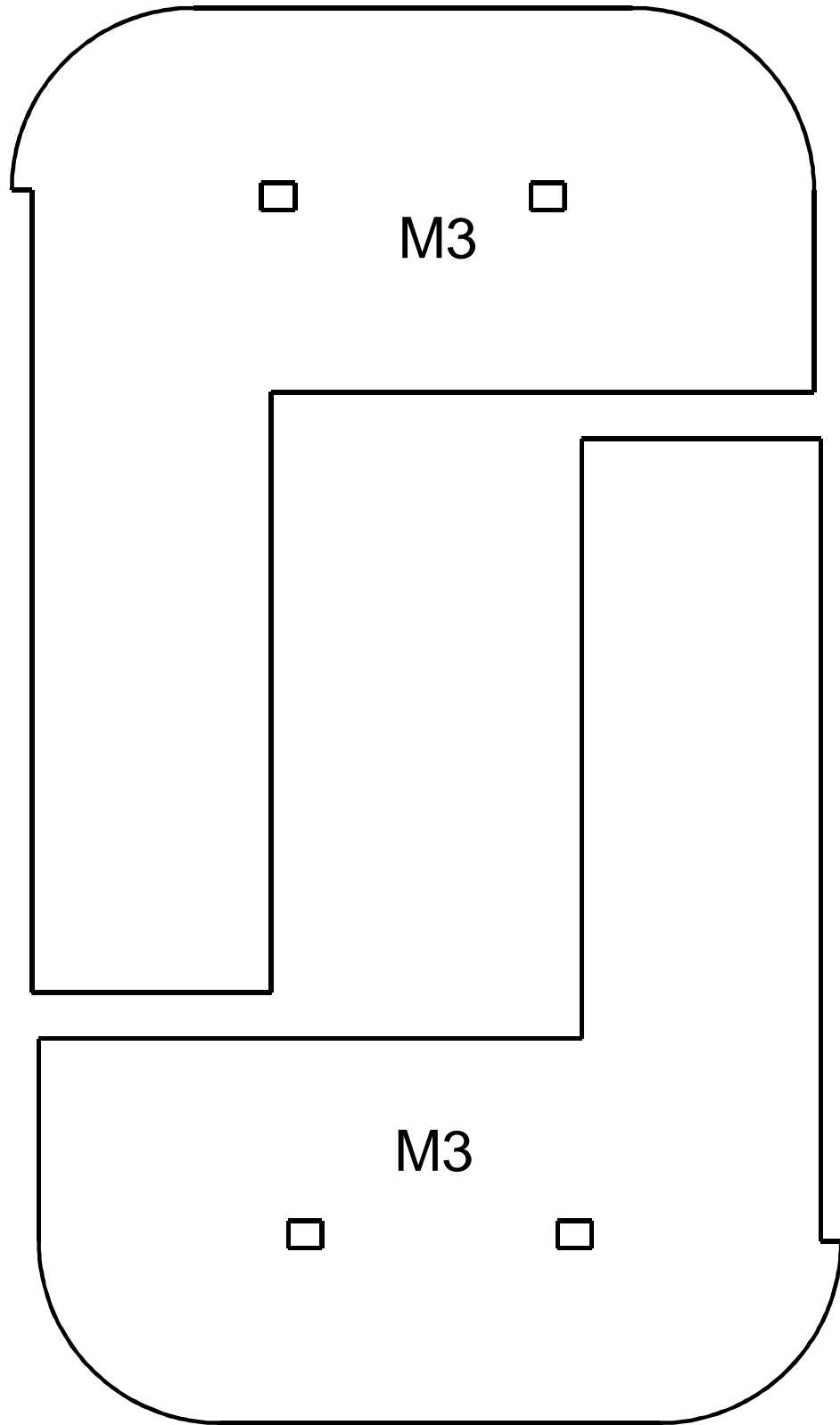

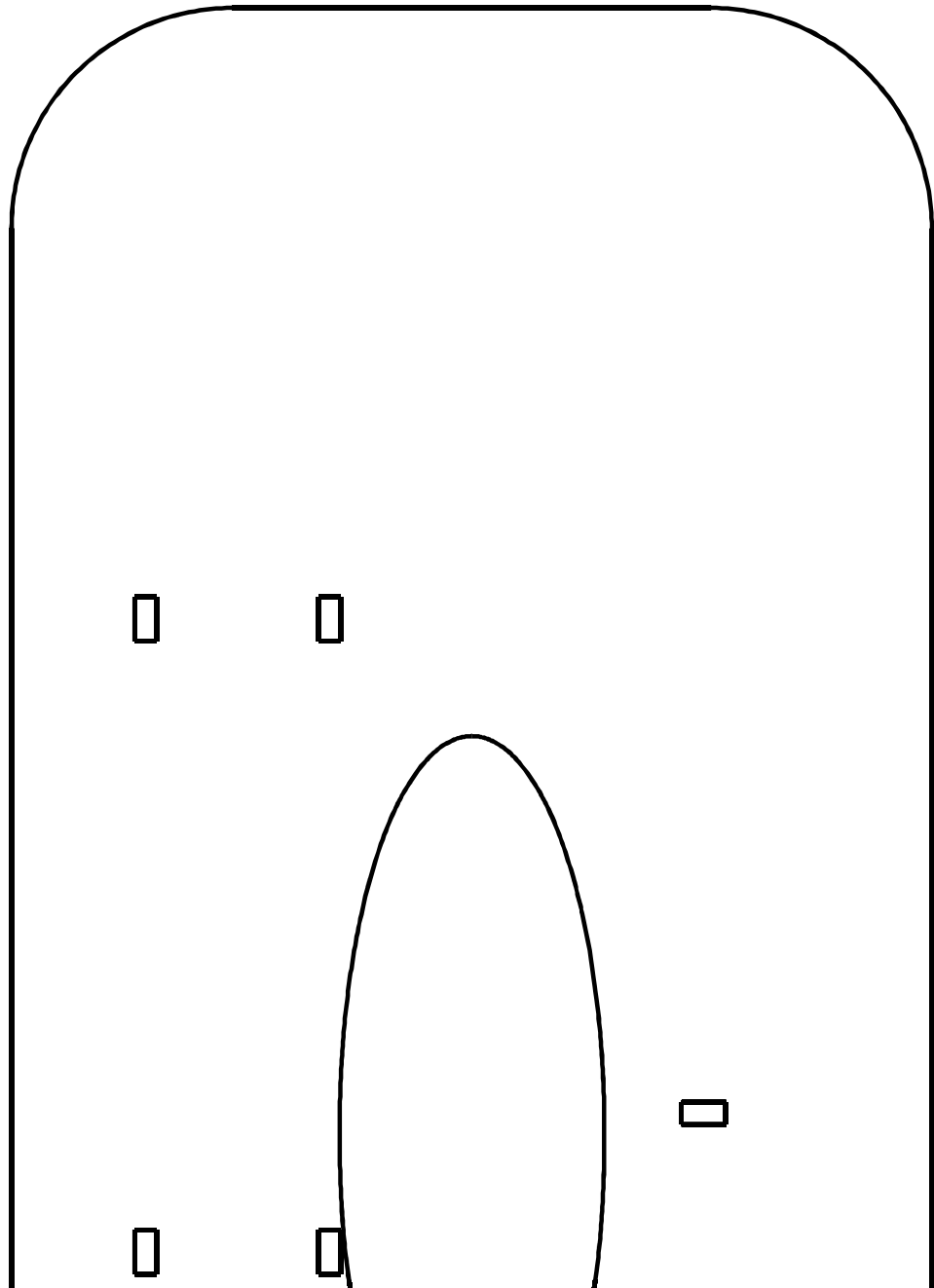
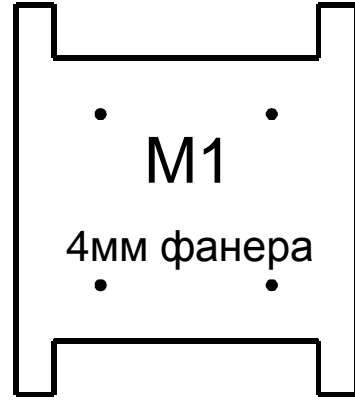
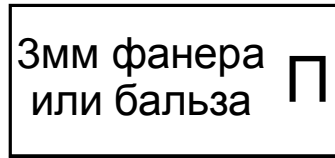
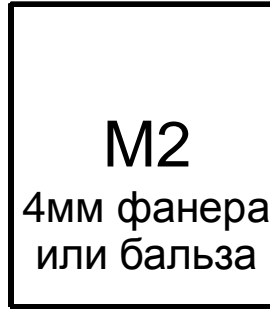
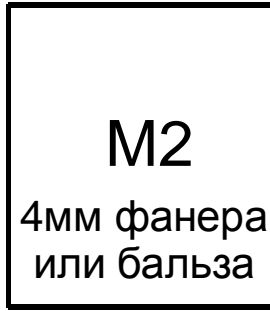

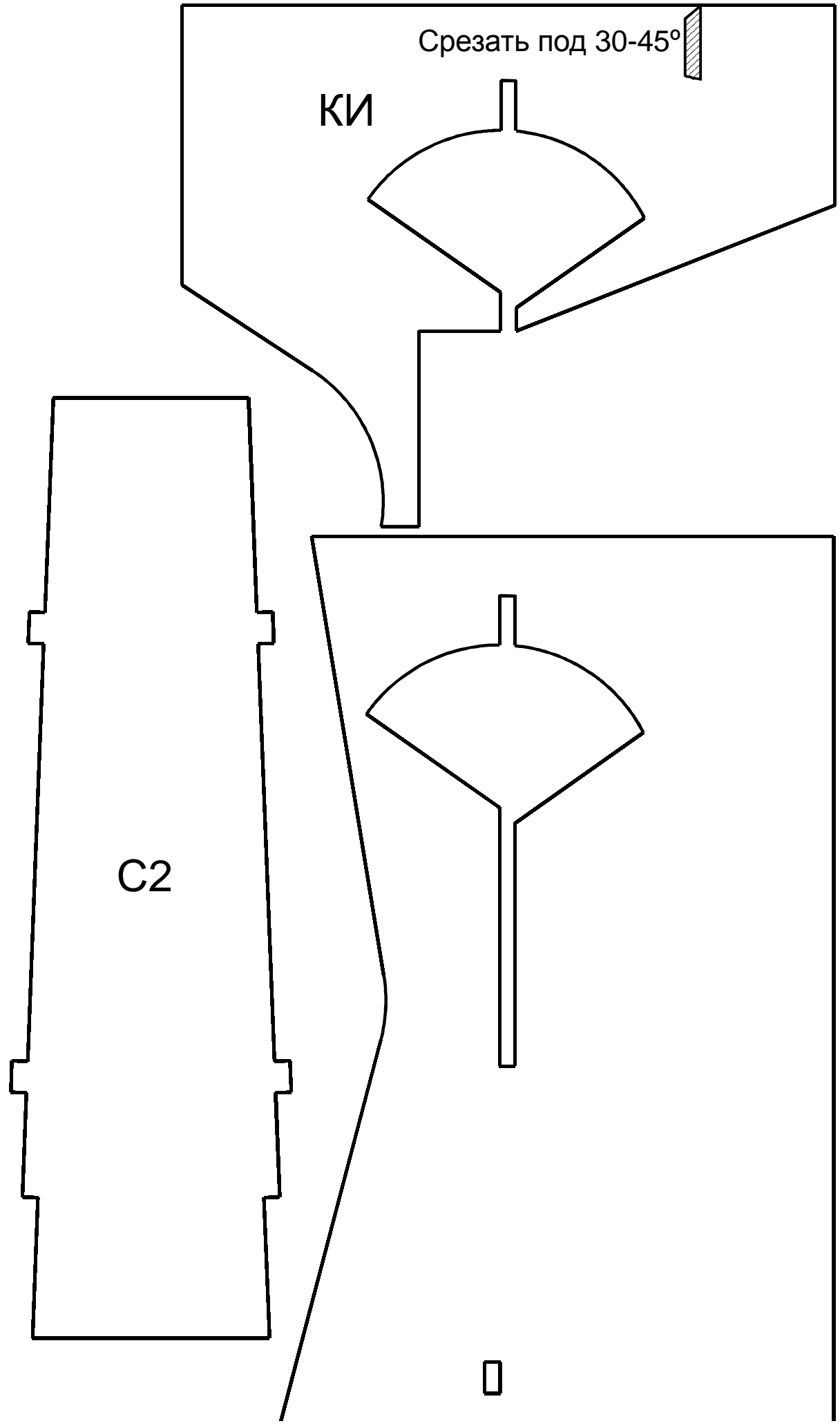

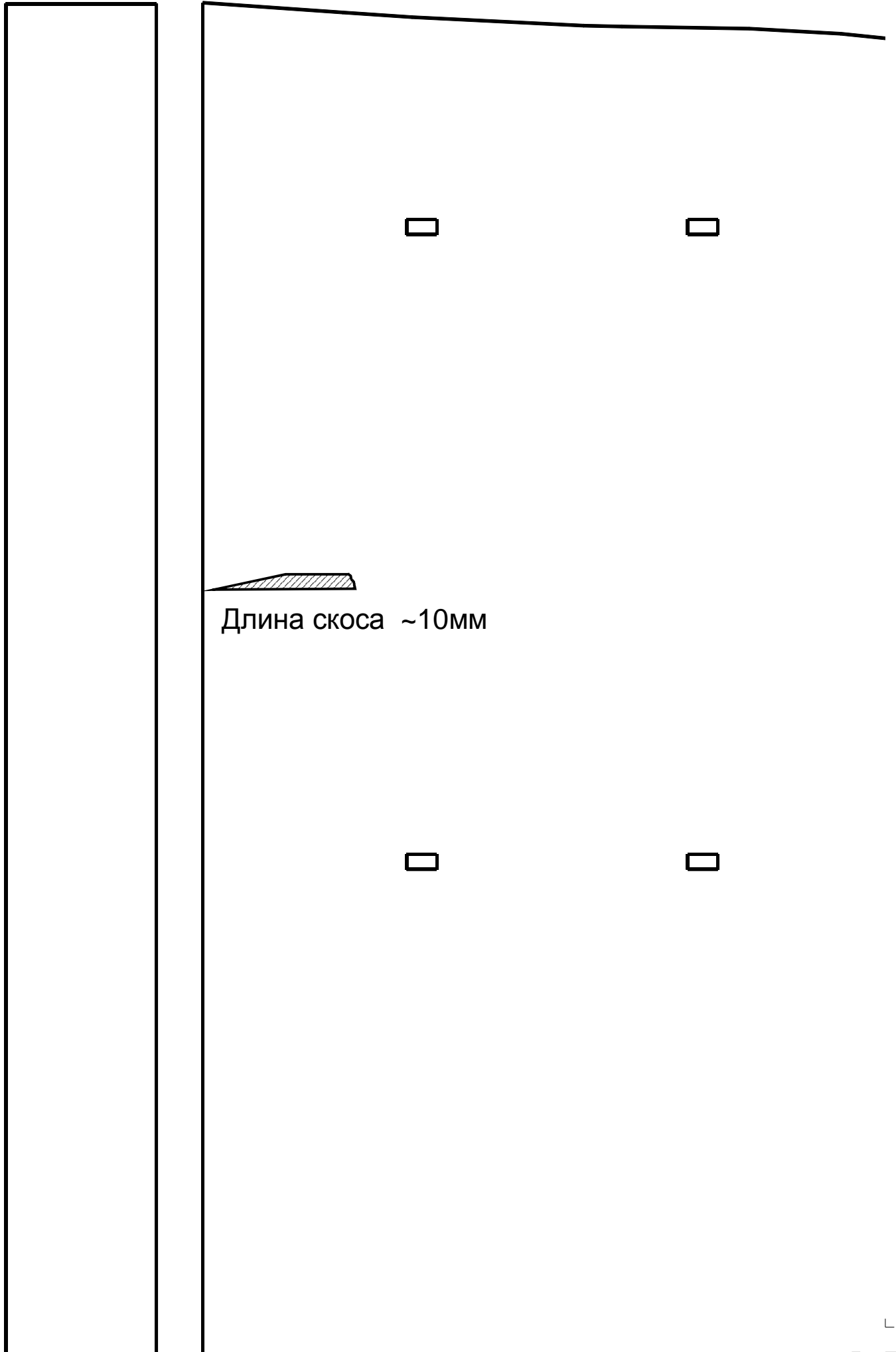

Длина скоса ~10мм

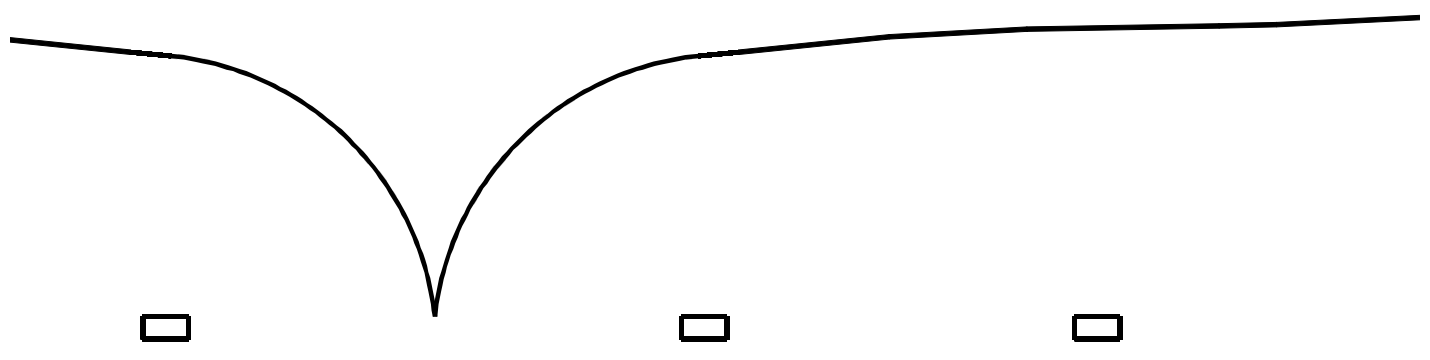

направление сгиба

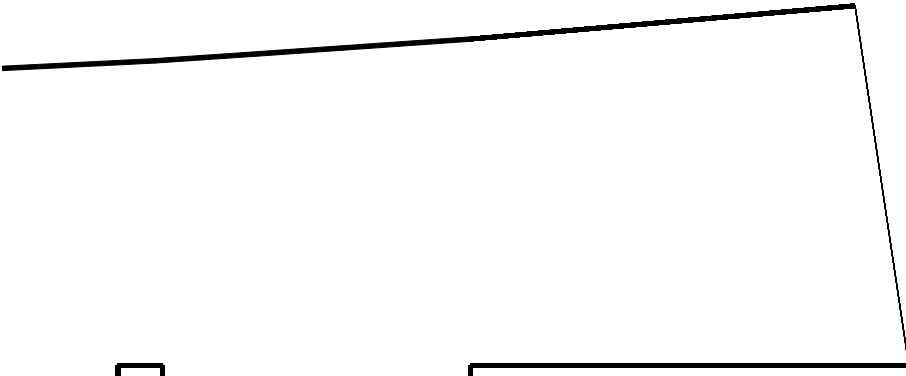

Срезать под 30-45°

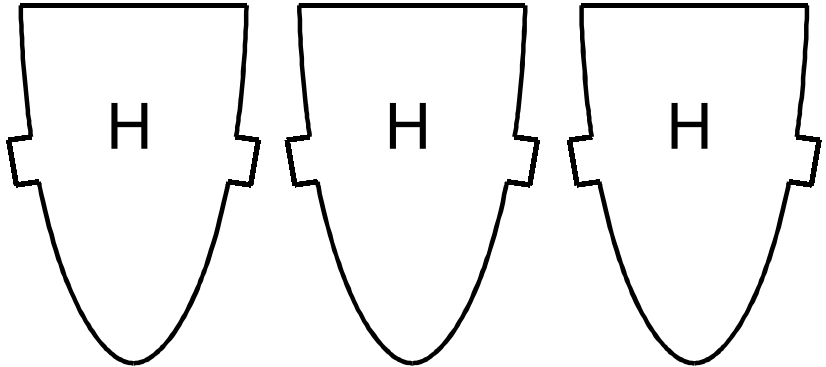
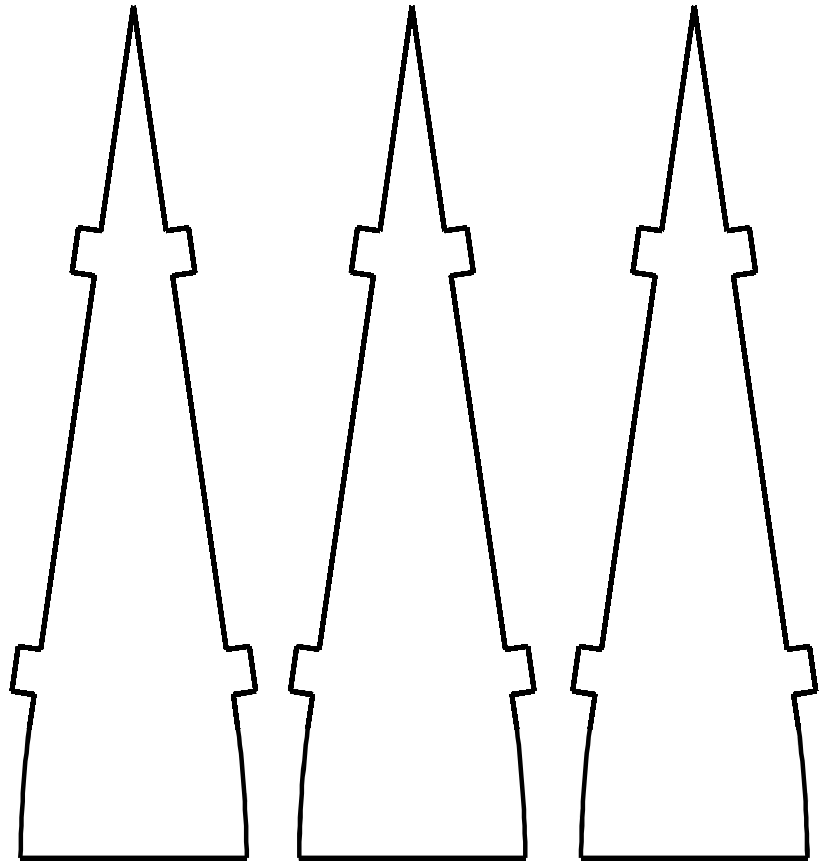

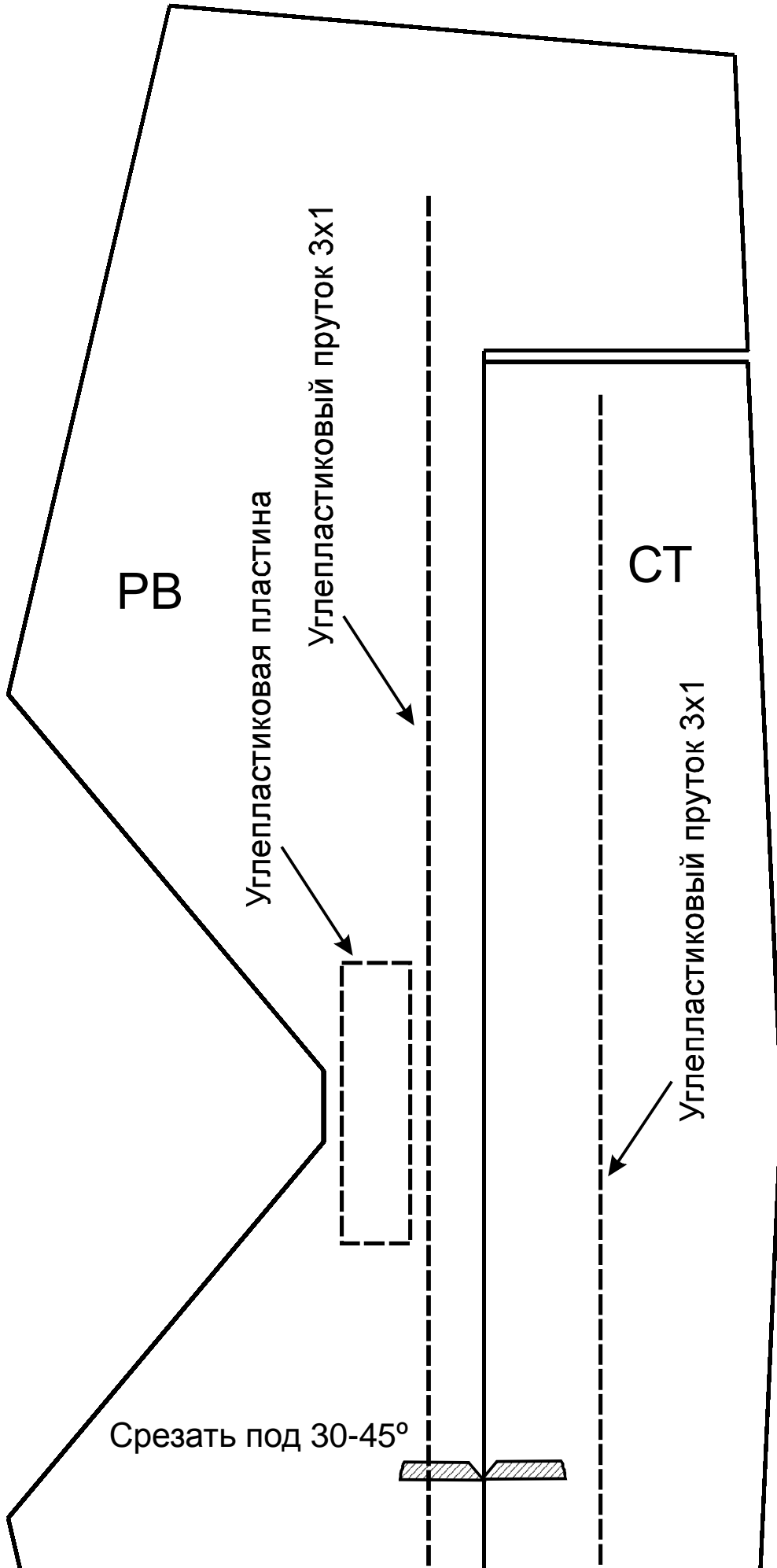

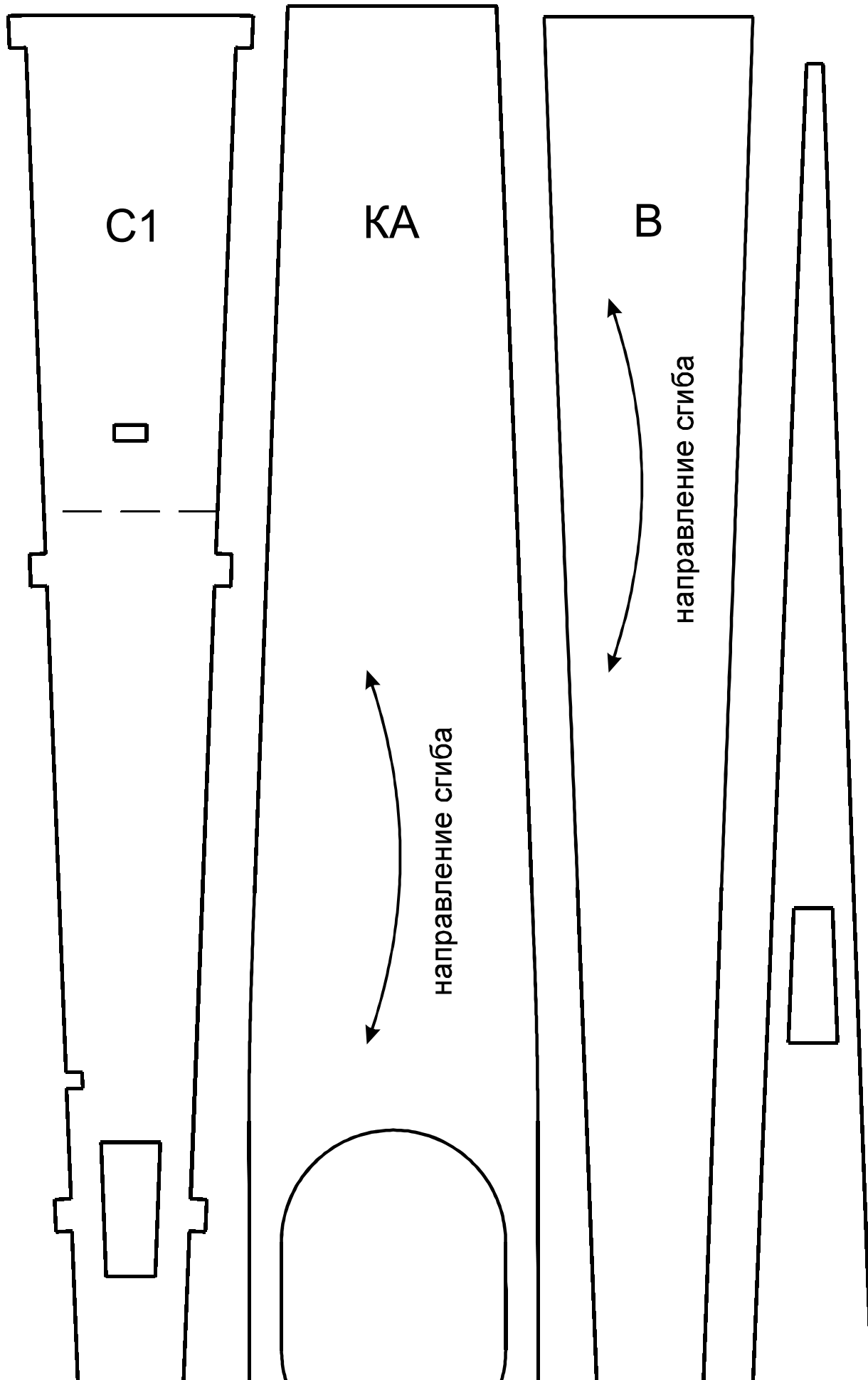

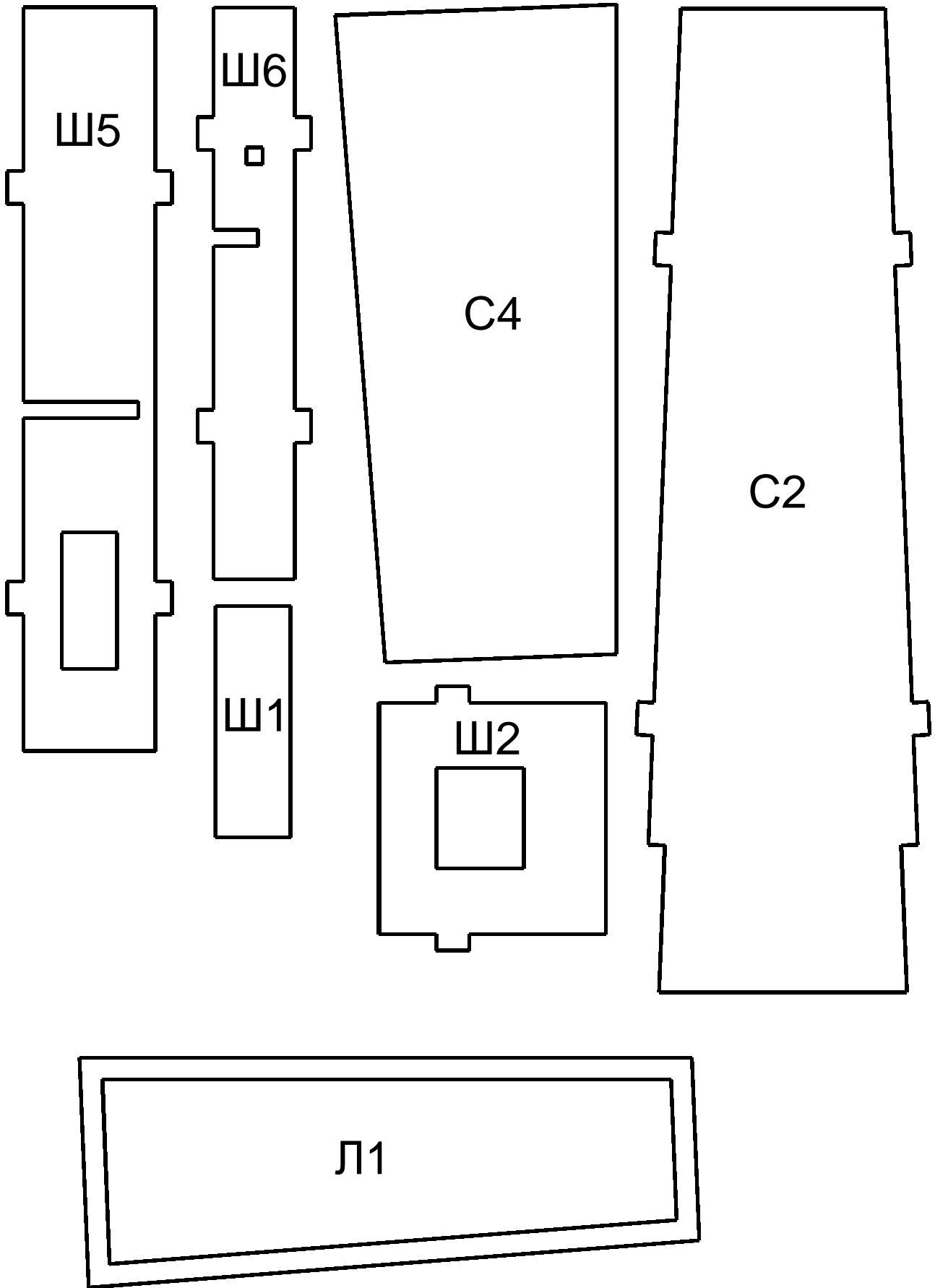

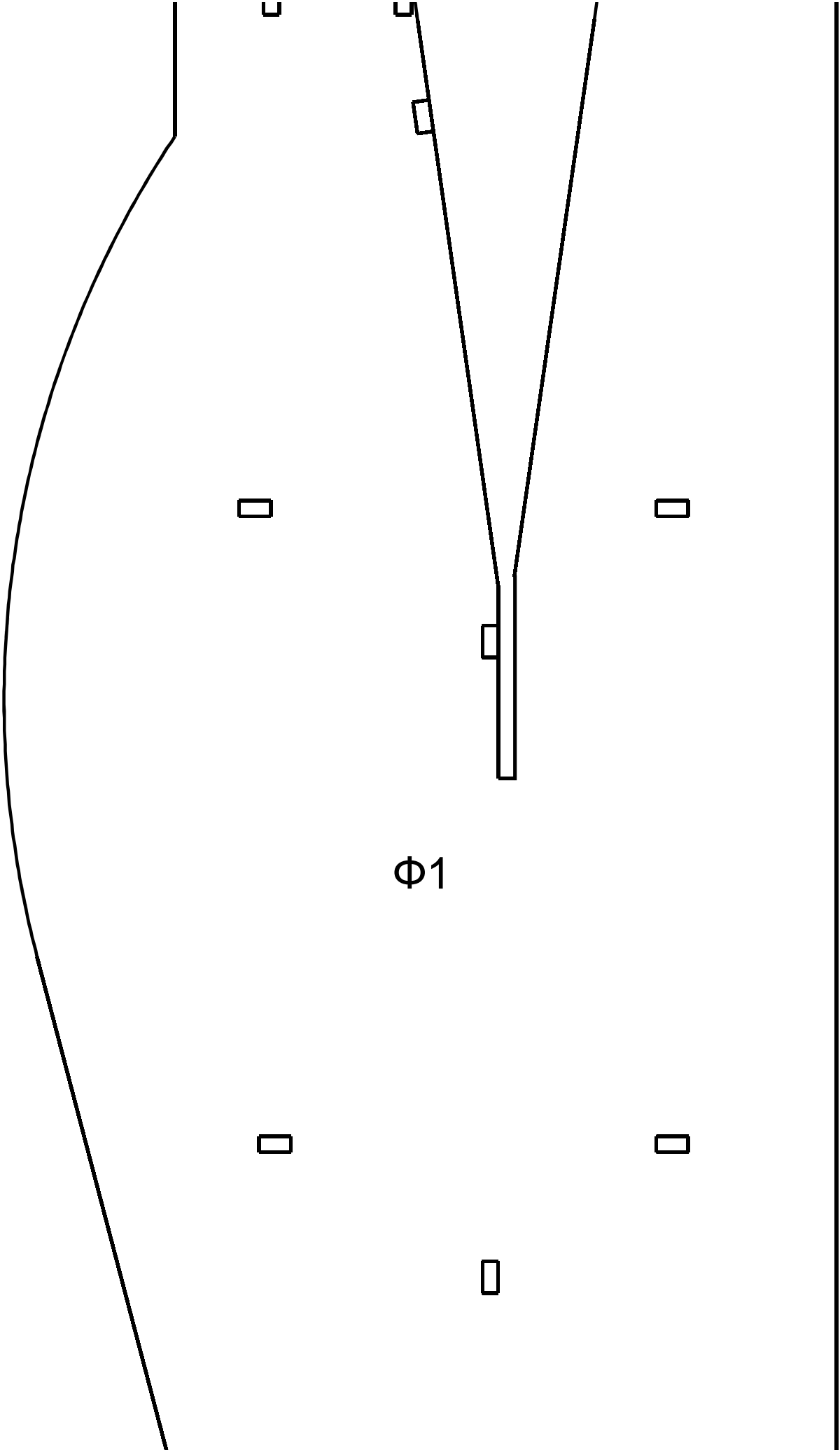

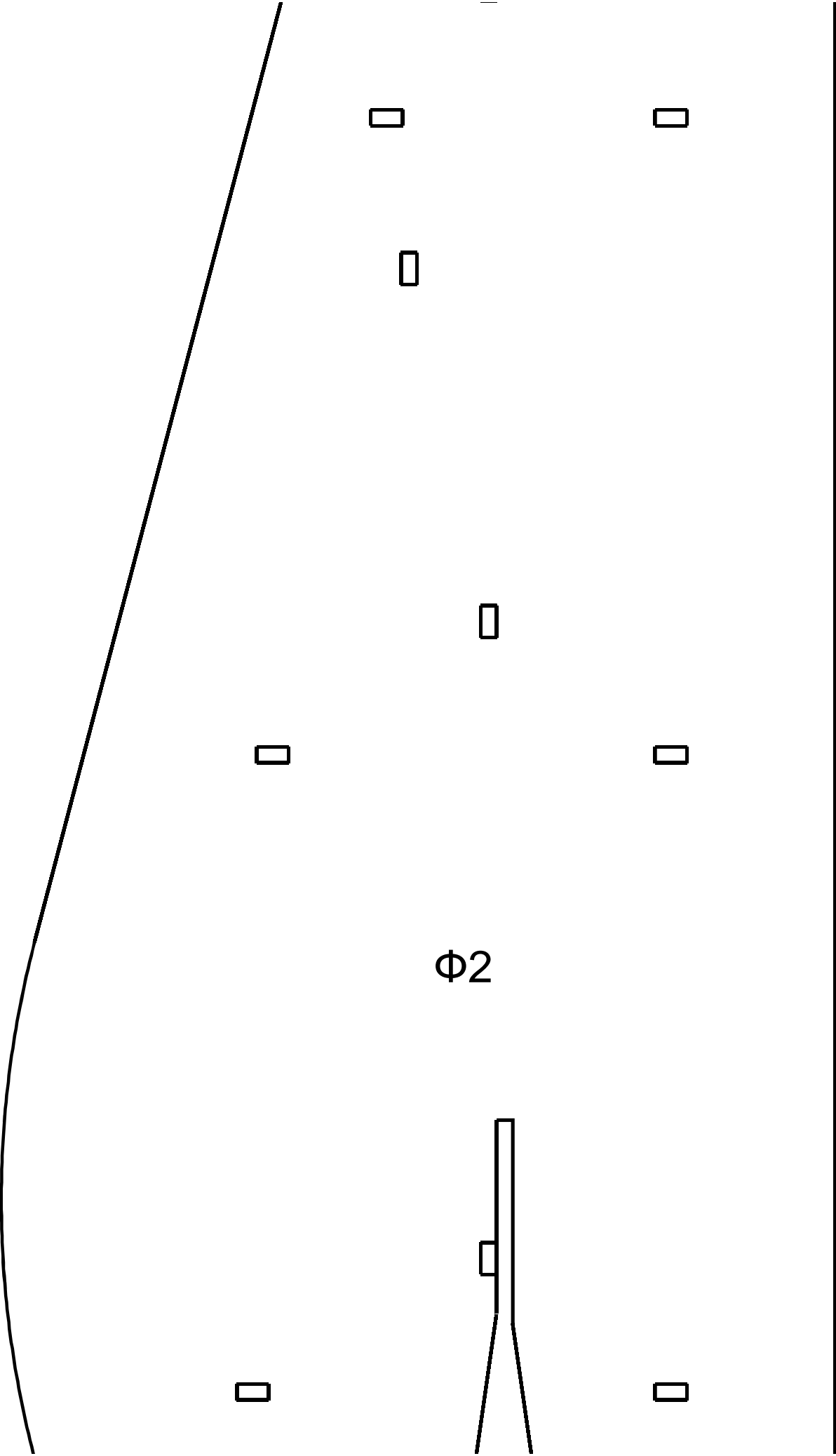

Двойная потолочка
или ПЛОТНЫЙ ПОТОЛОЧНЫЙ ПЛИНТУС

Л

Сверьте размер выреза
с размерами сервопривода

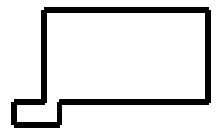
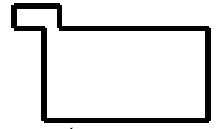



K1



K2



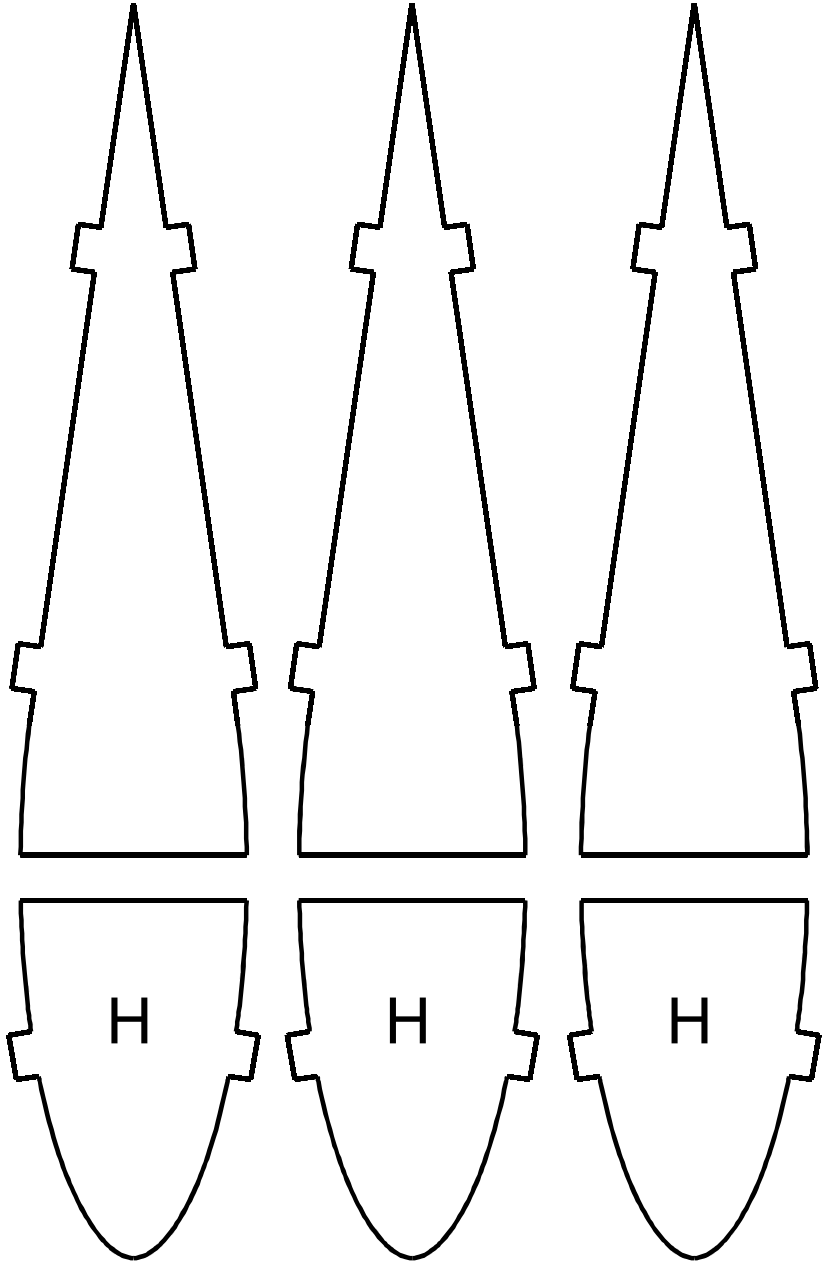

(8, 2)

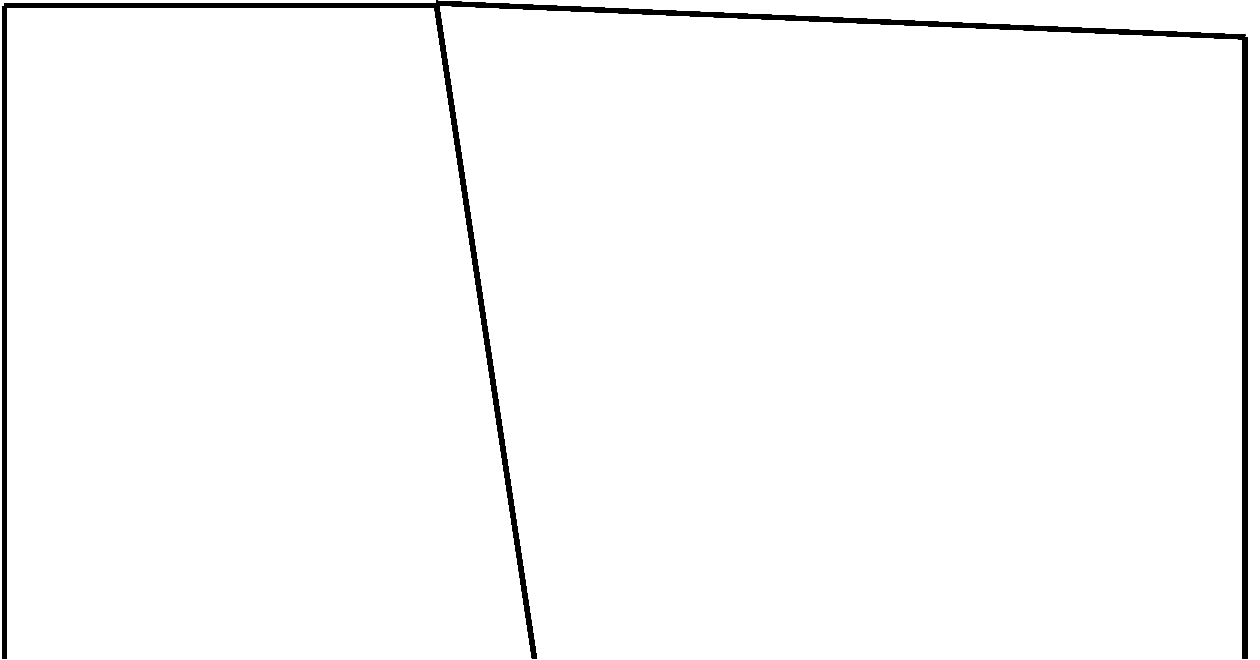
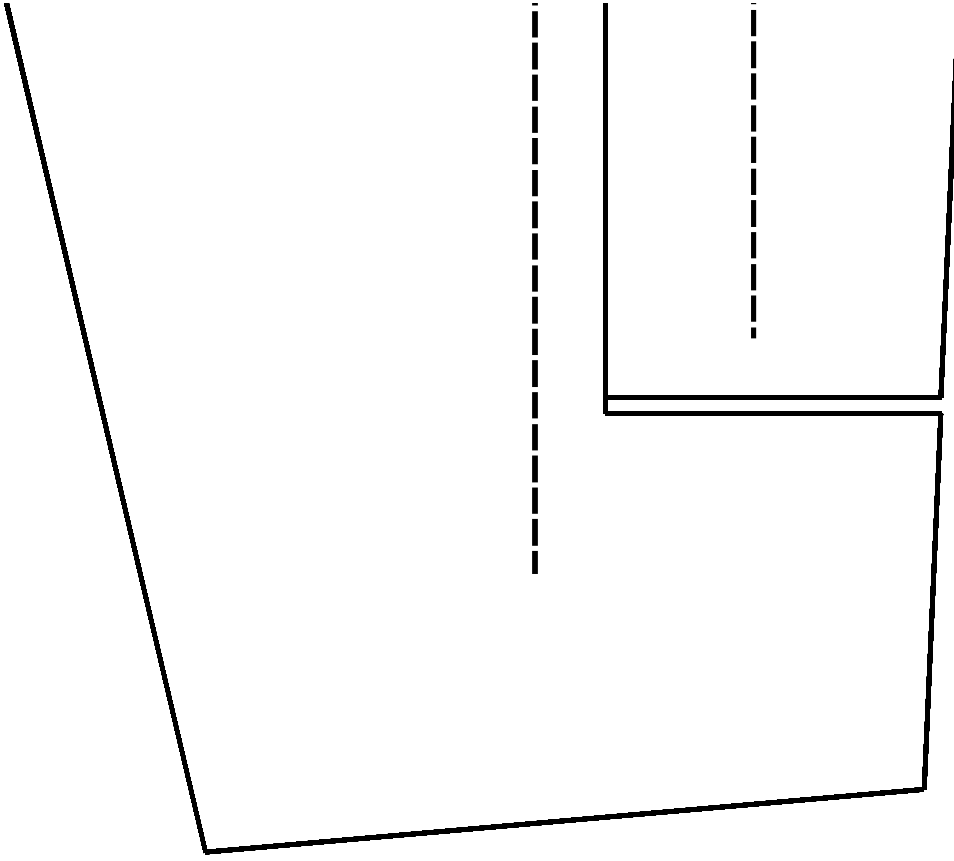

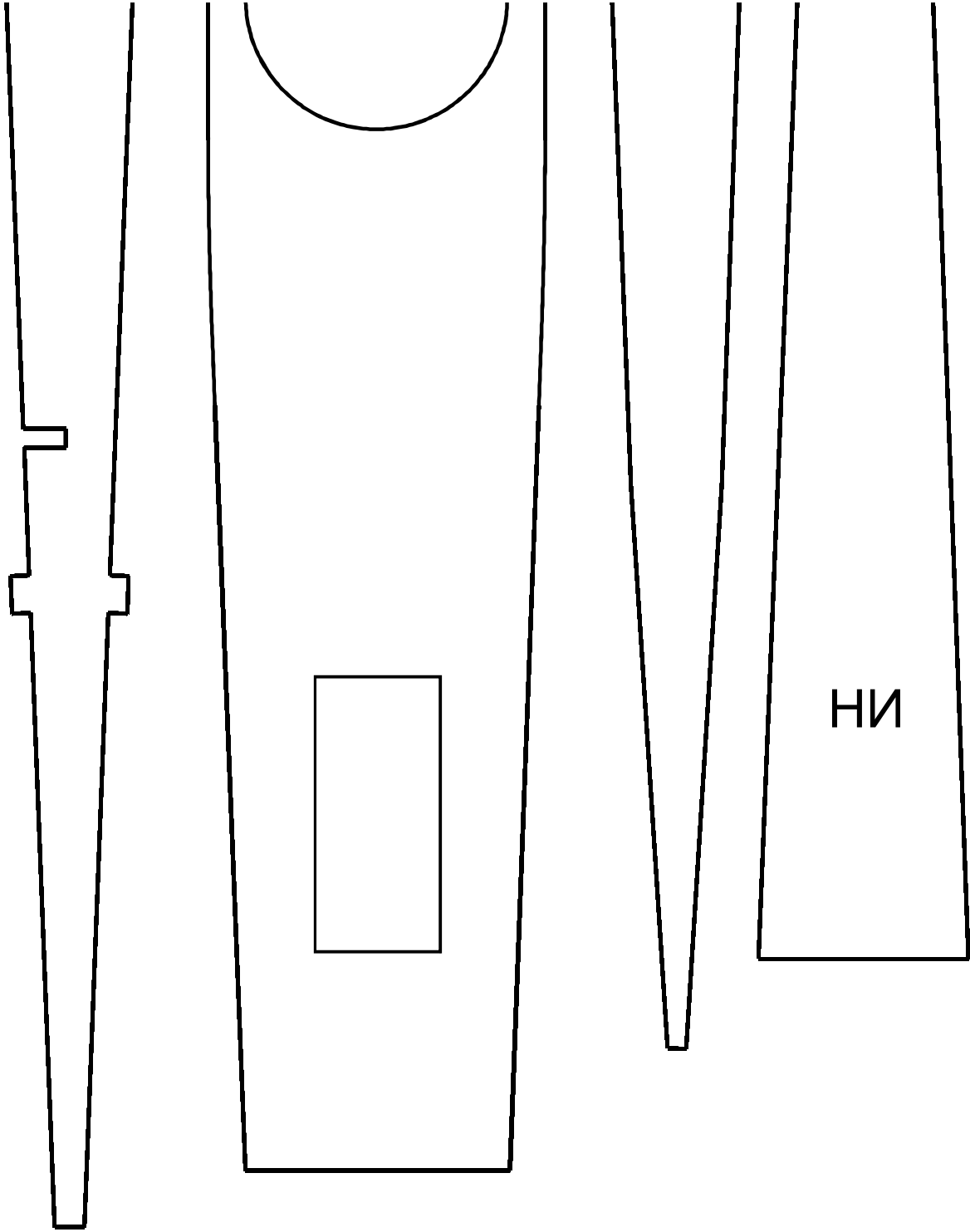

НИ

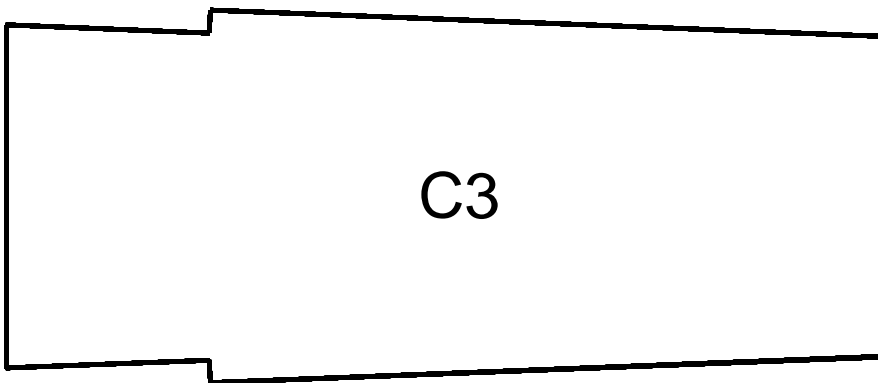

С3

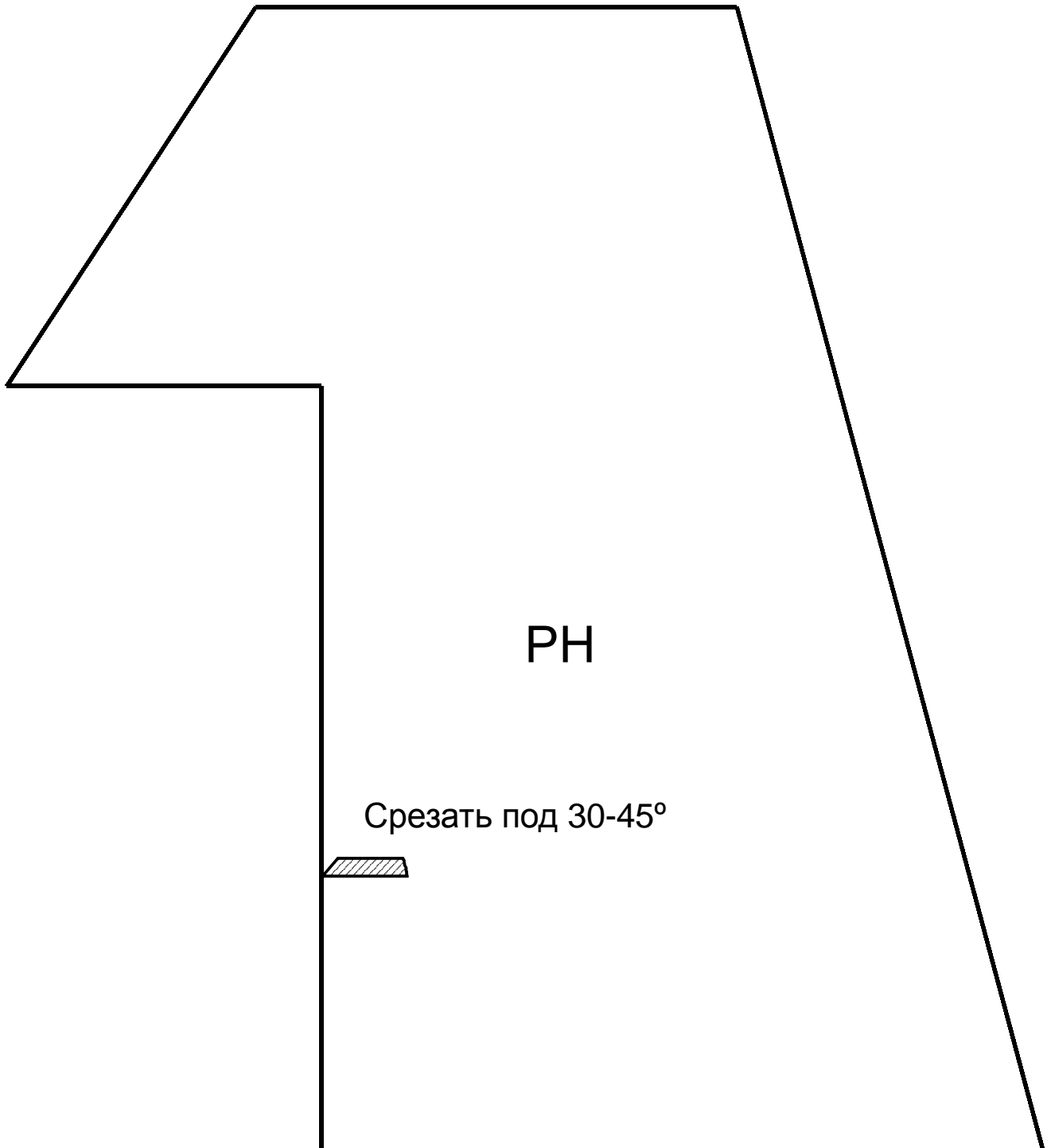
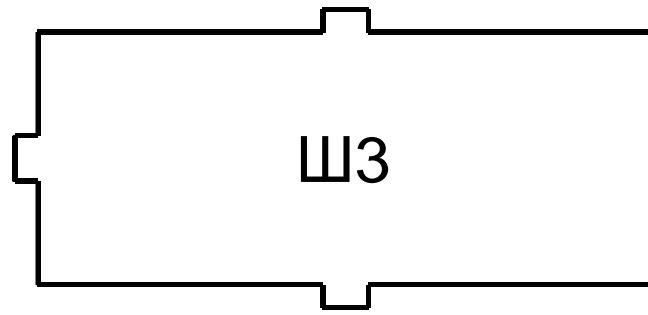

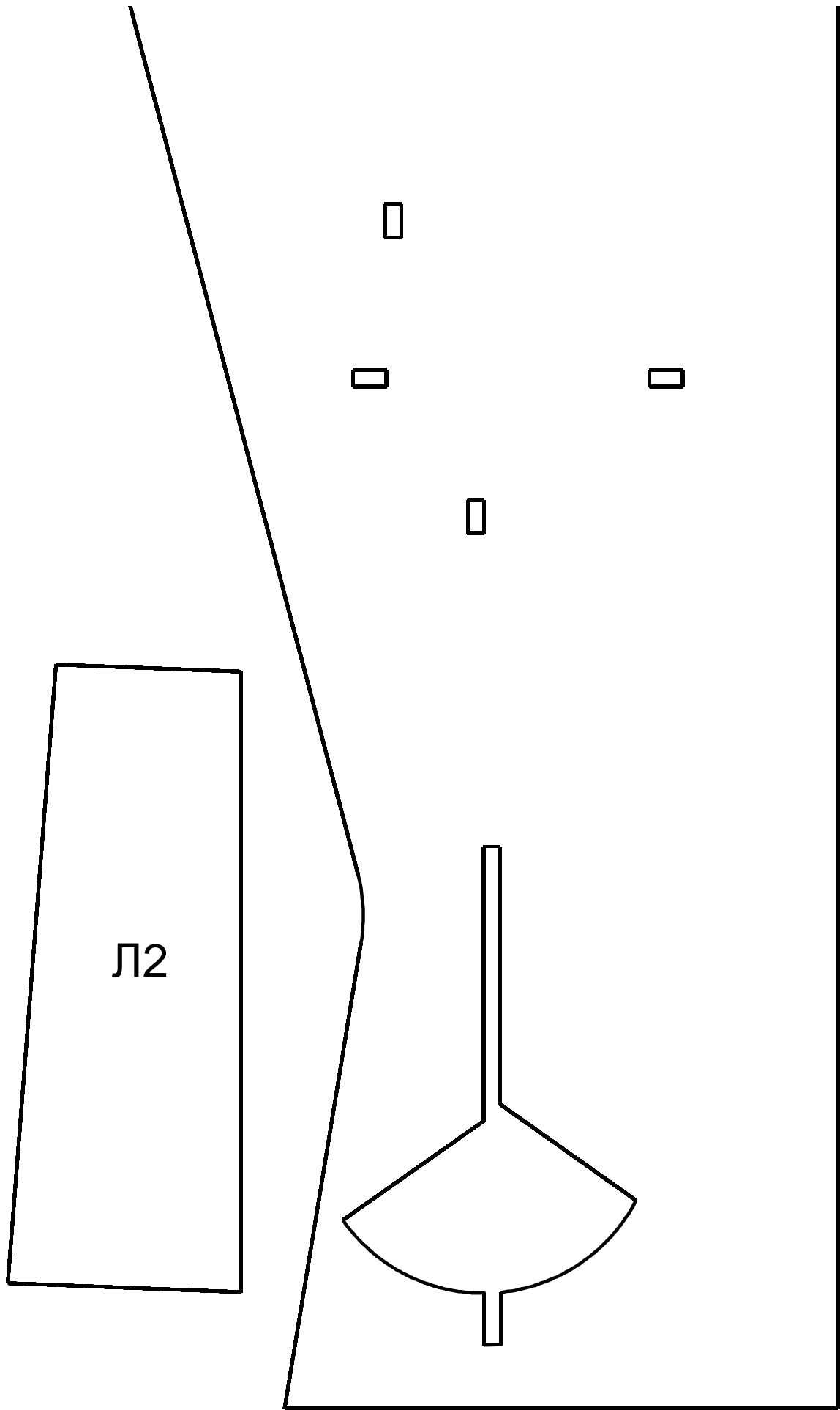

Л2

(4, 3)

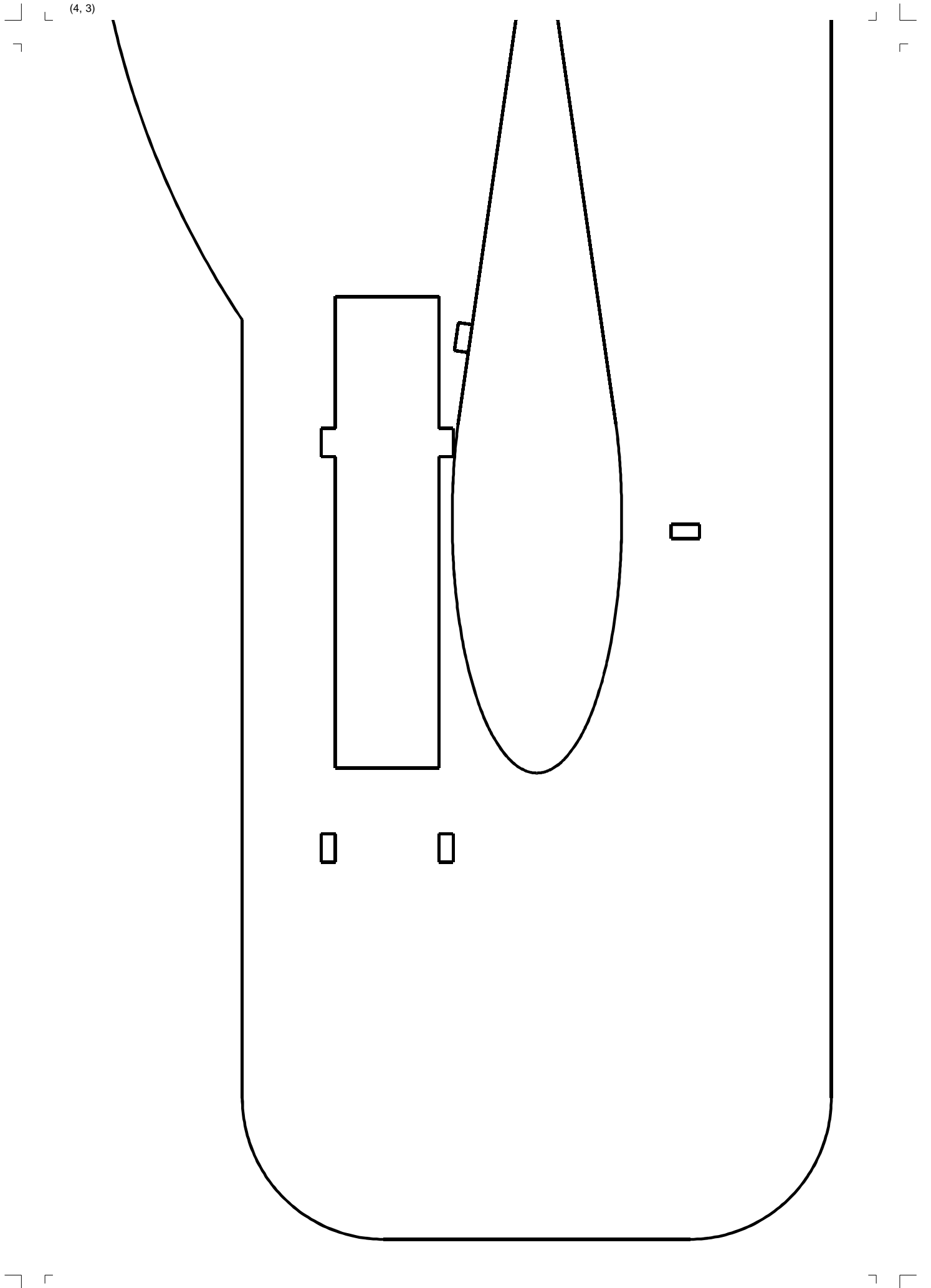

(5, 3)



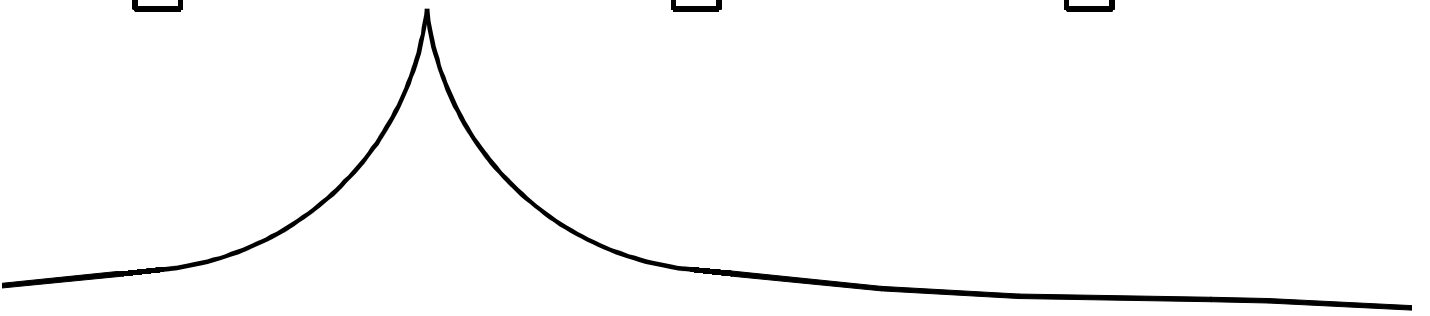



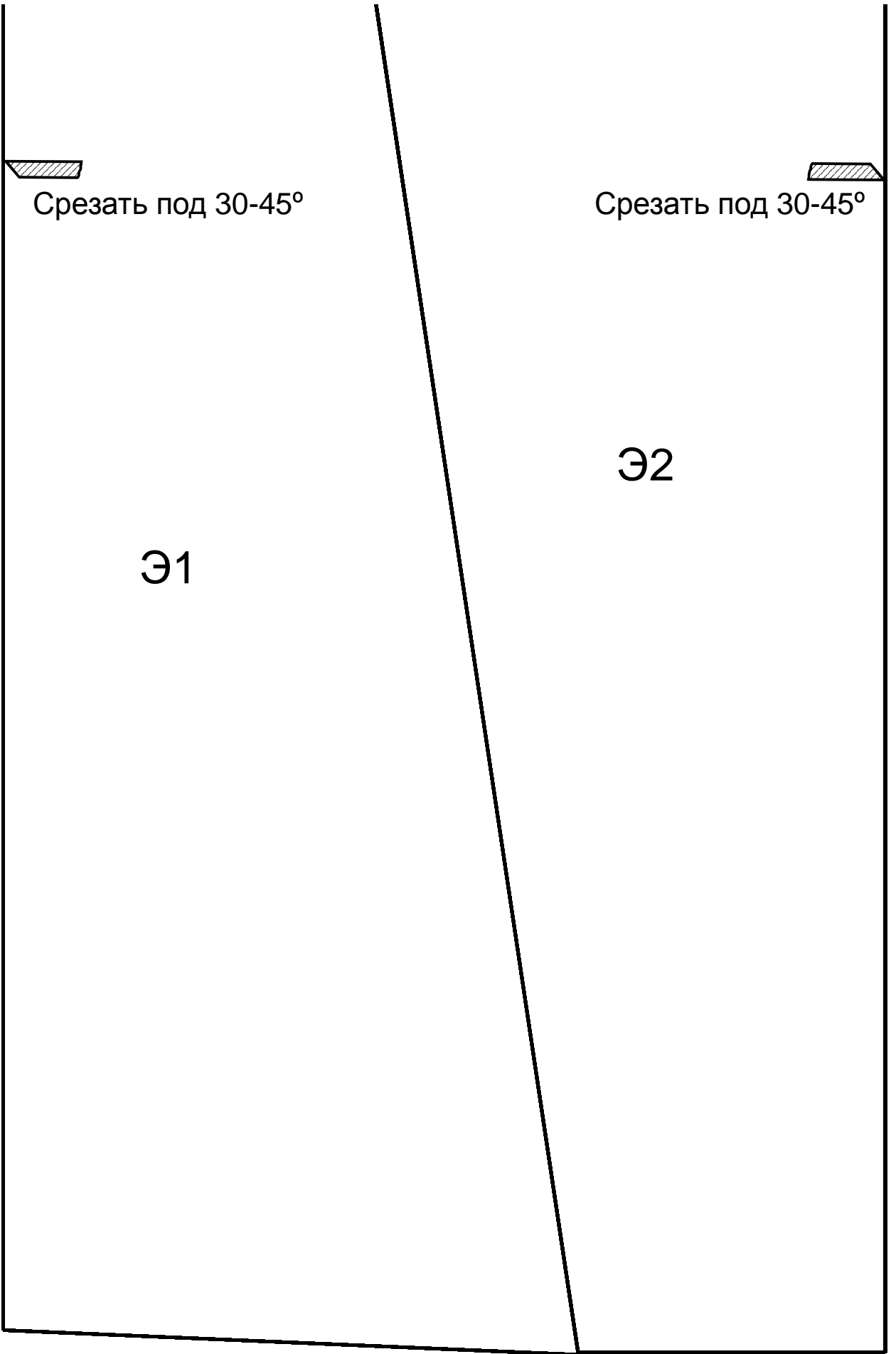

Срезать под 30-45°

Срезать под 30-45°

Э1

Э2