



www.flitetest.com



# FT Duster

## Recommended electronics:

Park 400 810 kv minimum

18-30 amp ESC

1300 - 2200 mAH 3s

(4) 9 gram servos

## Throws:

12° deflection

Expo 30%

## Weight Without Battery:

15.4 oz (439 g)

## Recommended Prop:

9 x 4.7 or 9 x 6

black = cut

red = score 50%

blue = lightly crease

### Tiled plans dimensions:

1	2	3	4	5	6	7	8
9	10	11	12	13	14	15	16
17	18	19					

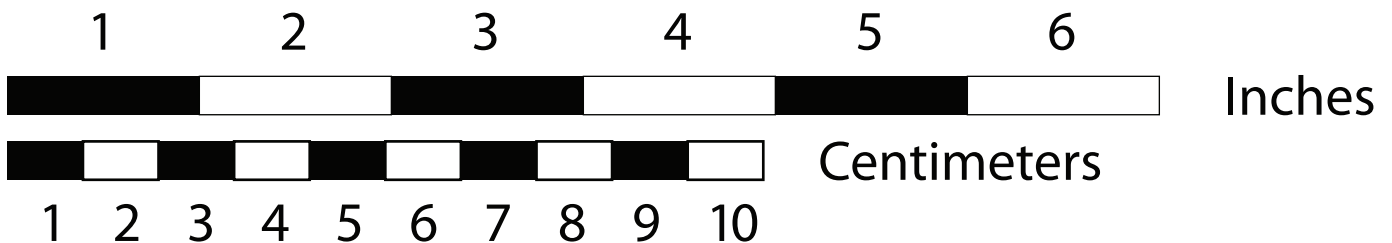

Design By: Josh Bixler

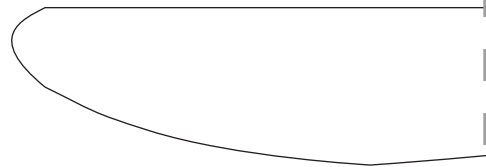
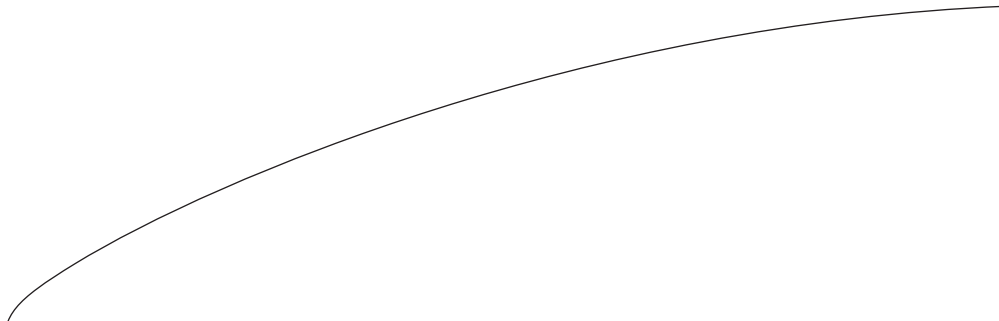
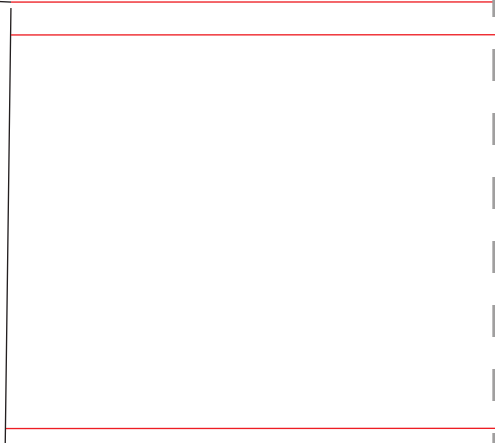
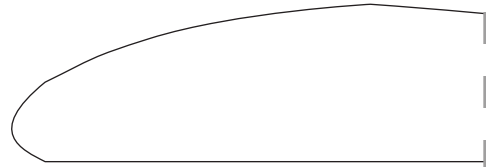
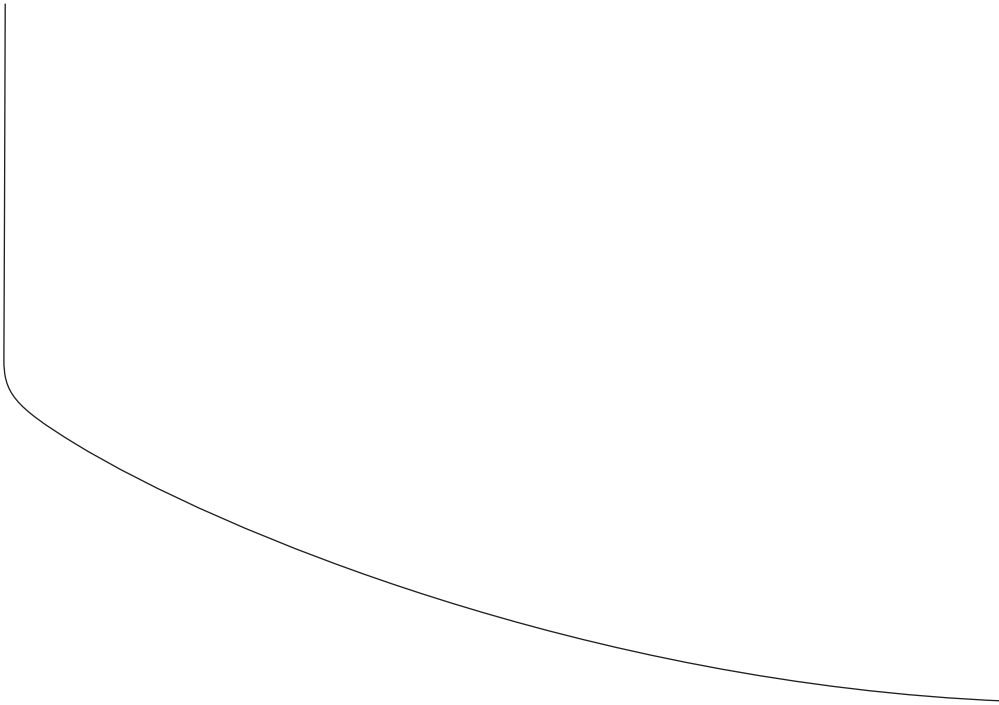

o

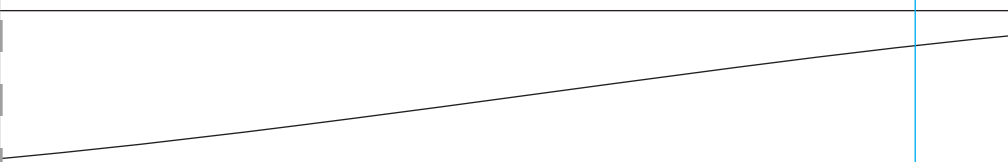
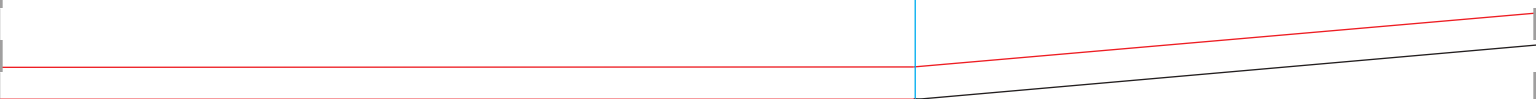
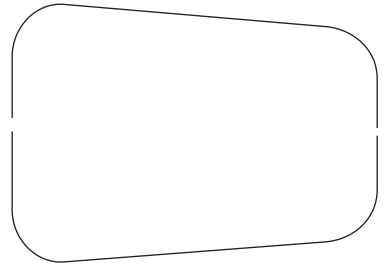
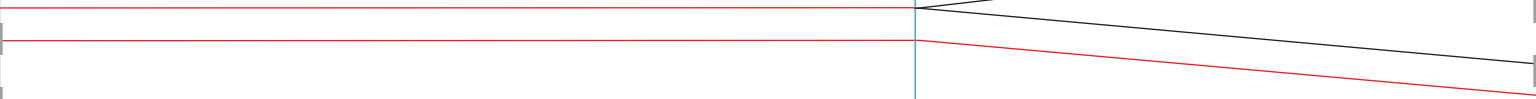
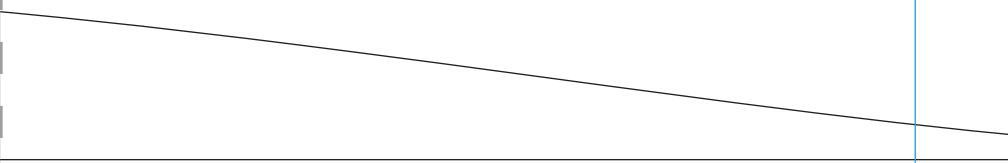

o

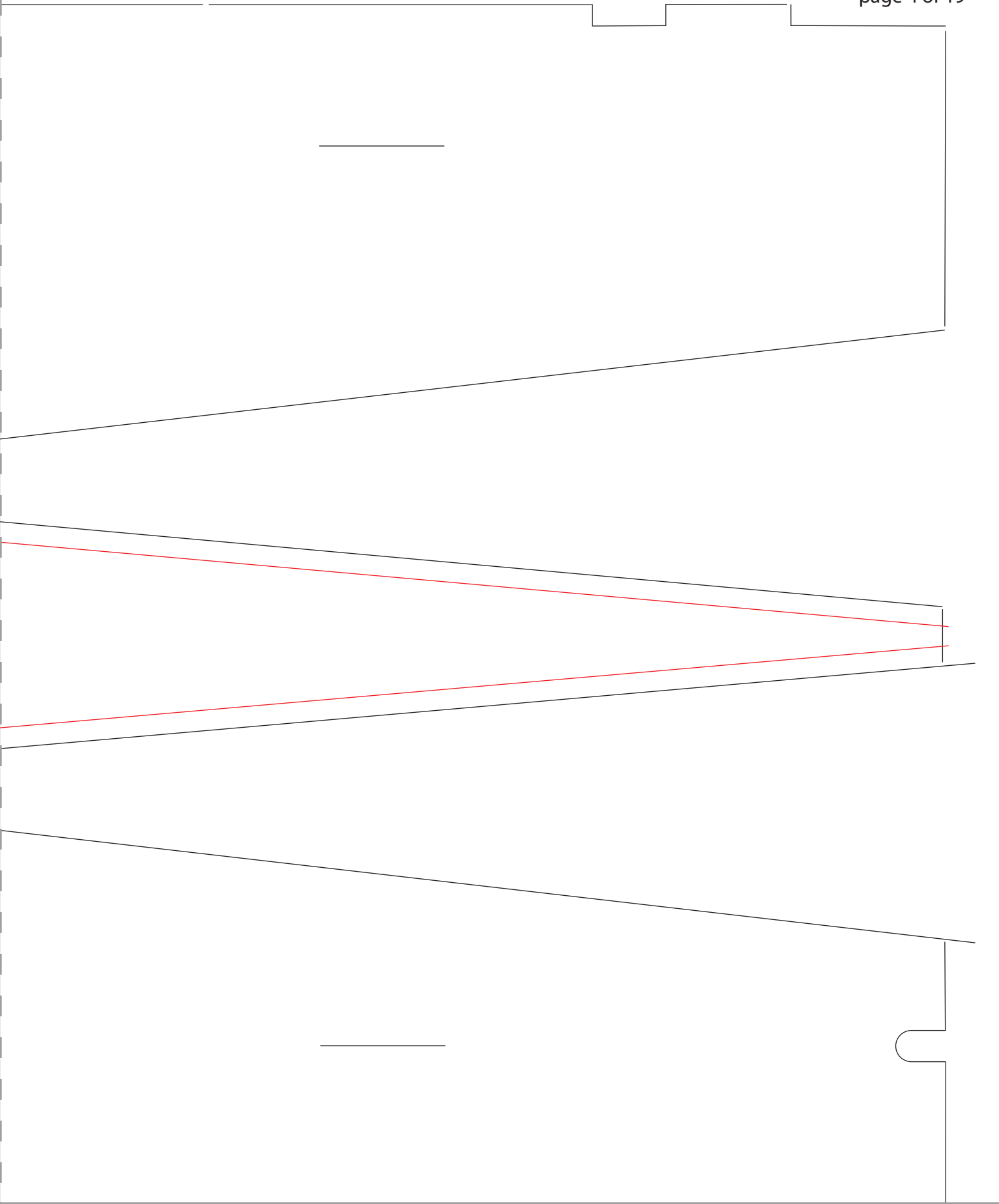

Total wingspan - 29.5 inches (750 mm)

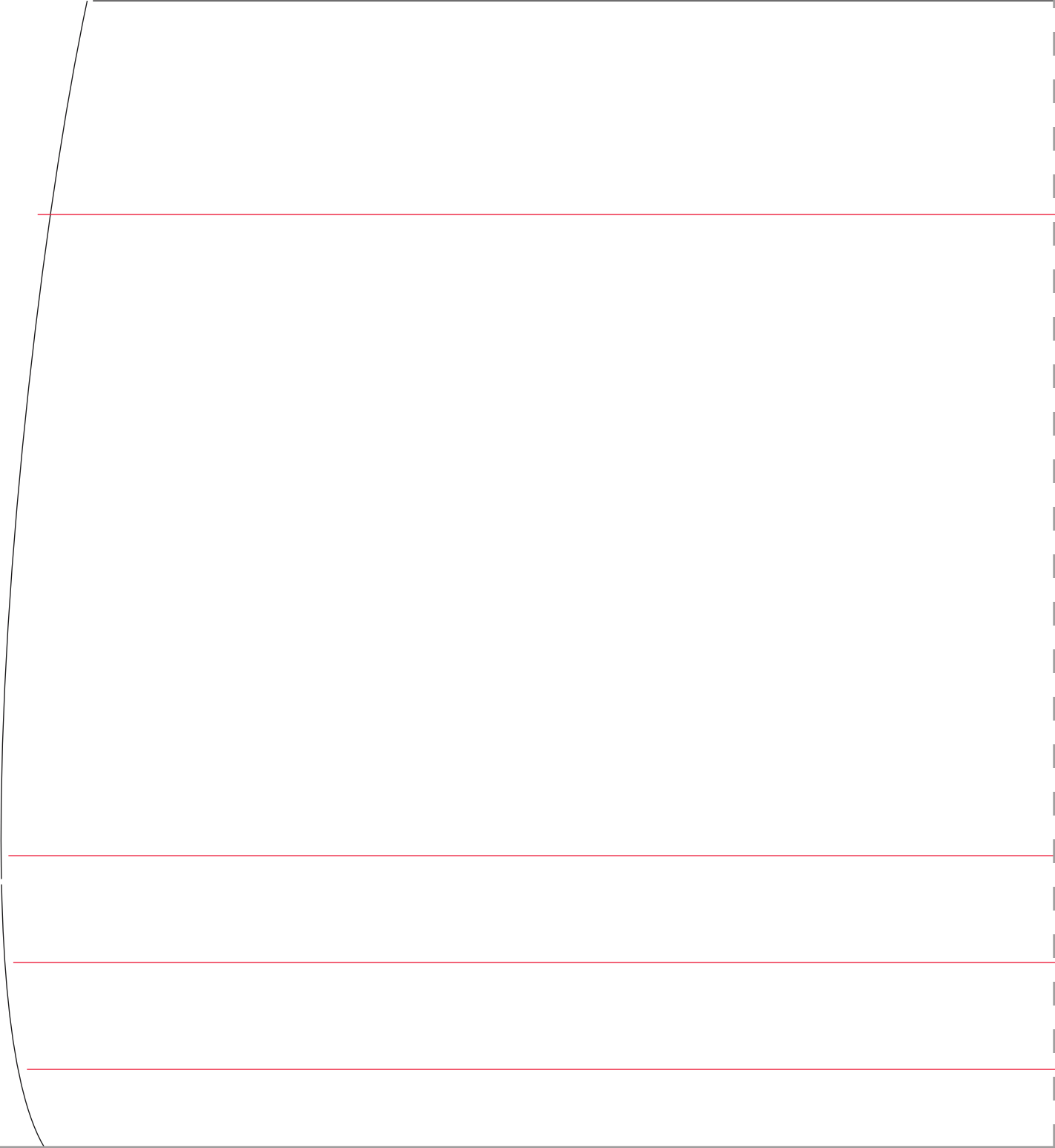

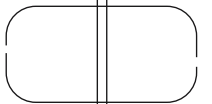
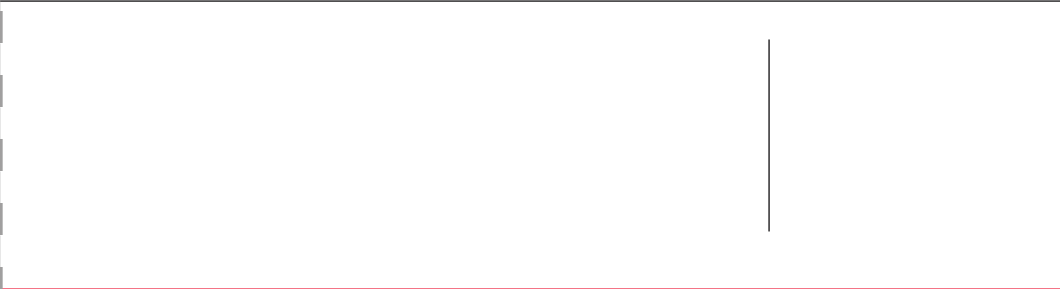

--



A large rectangular area with a black border on the top, left, and bottom, and a curved black border on the right. It contains four horizontal red lines for writing.

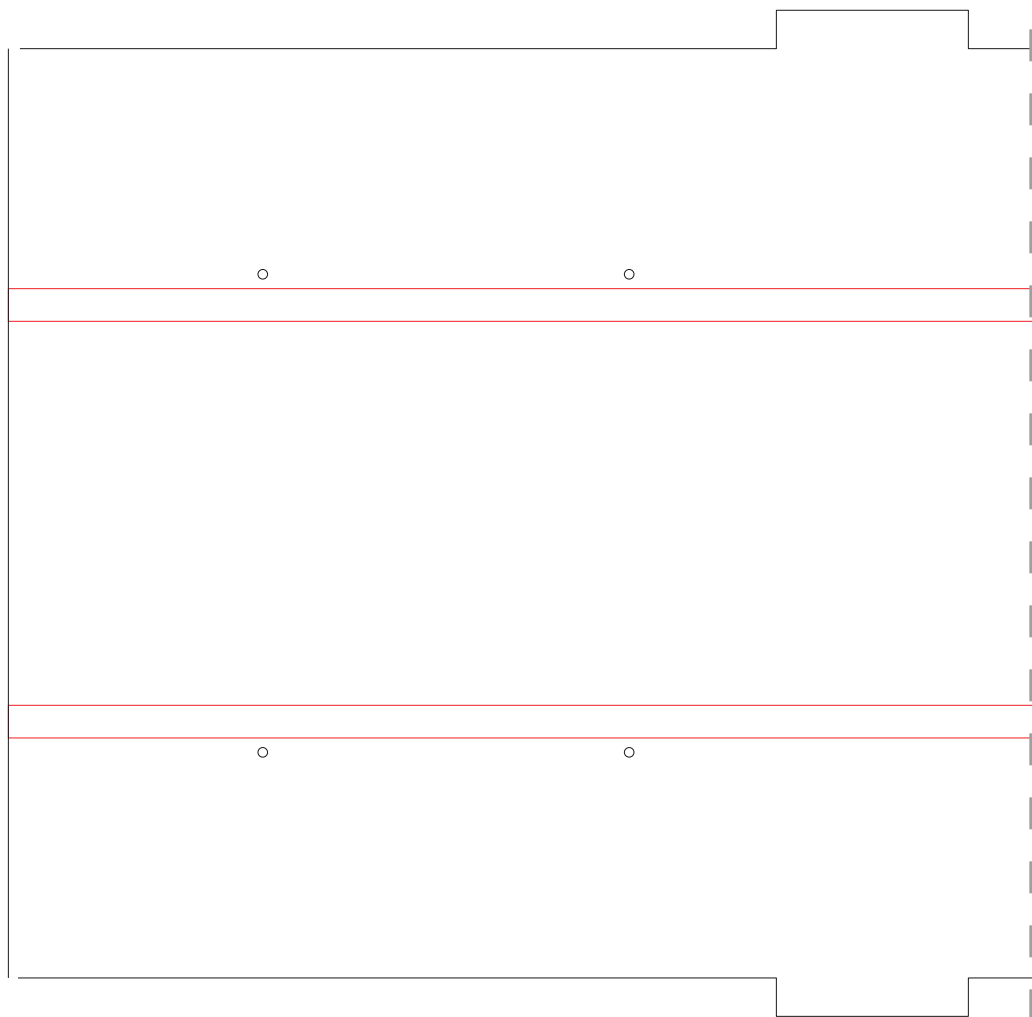
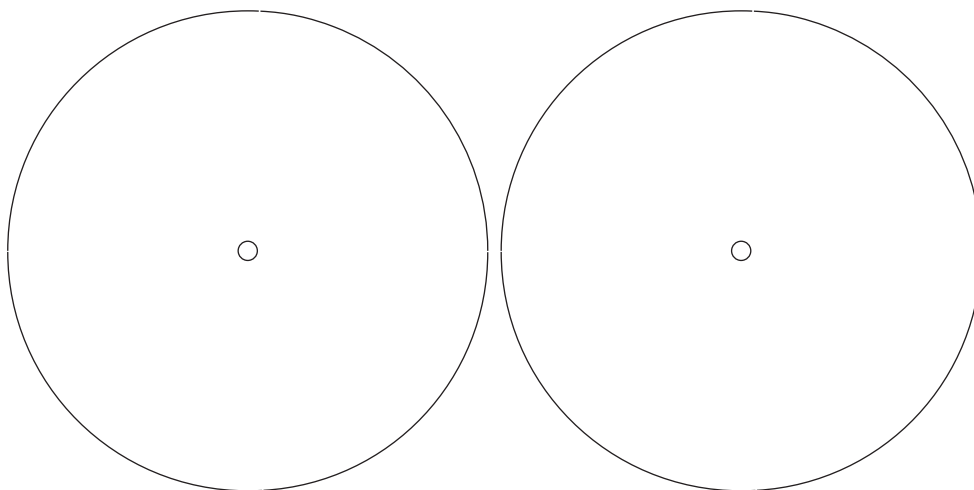



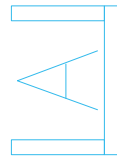

o



o

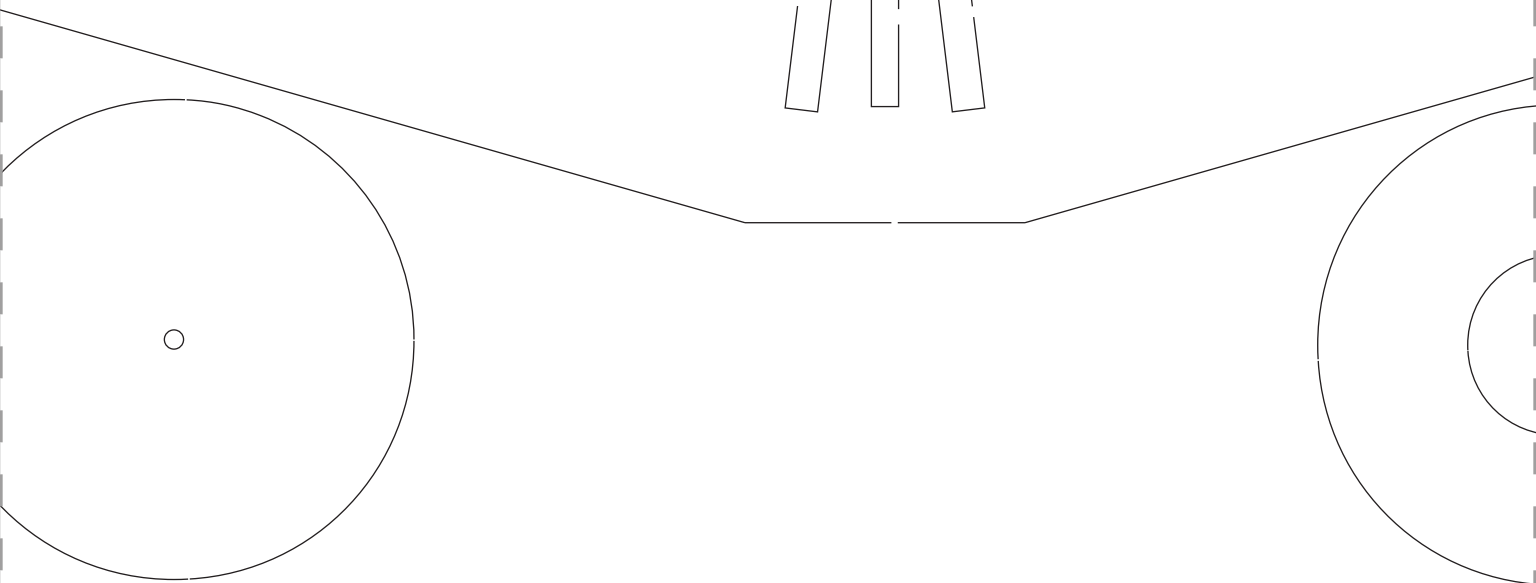
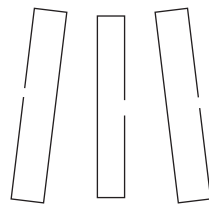
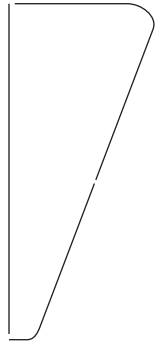
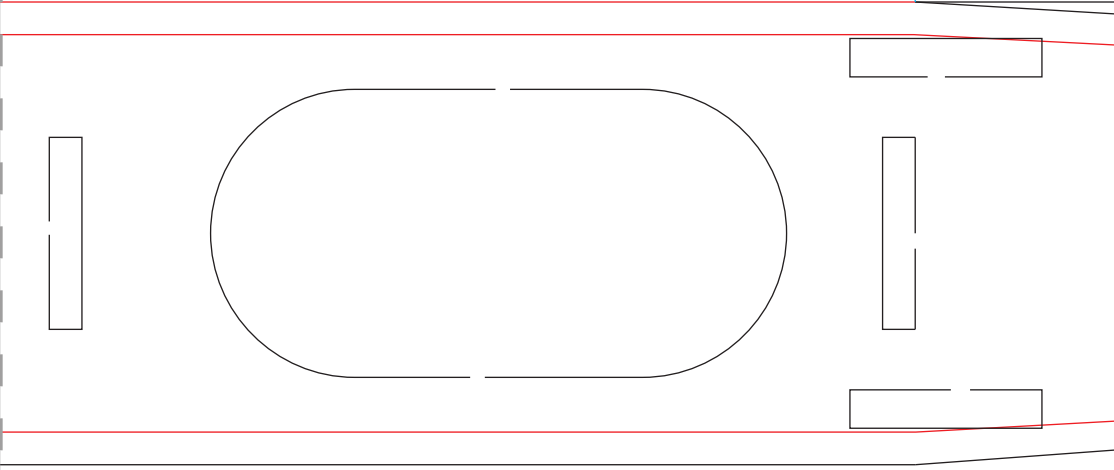

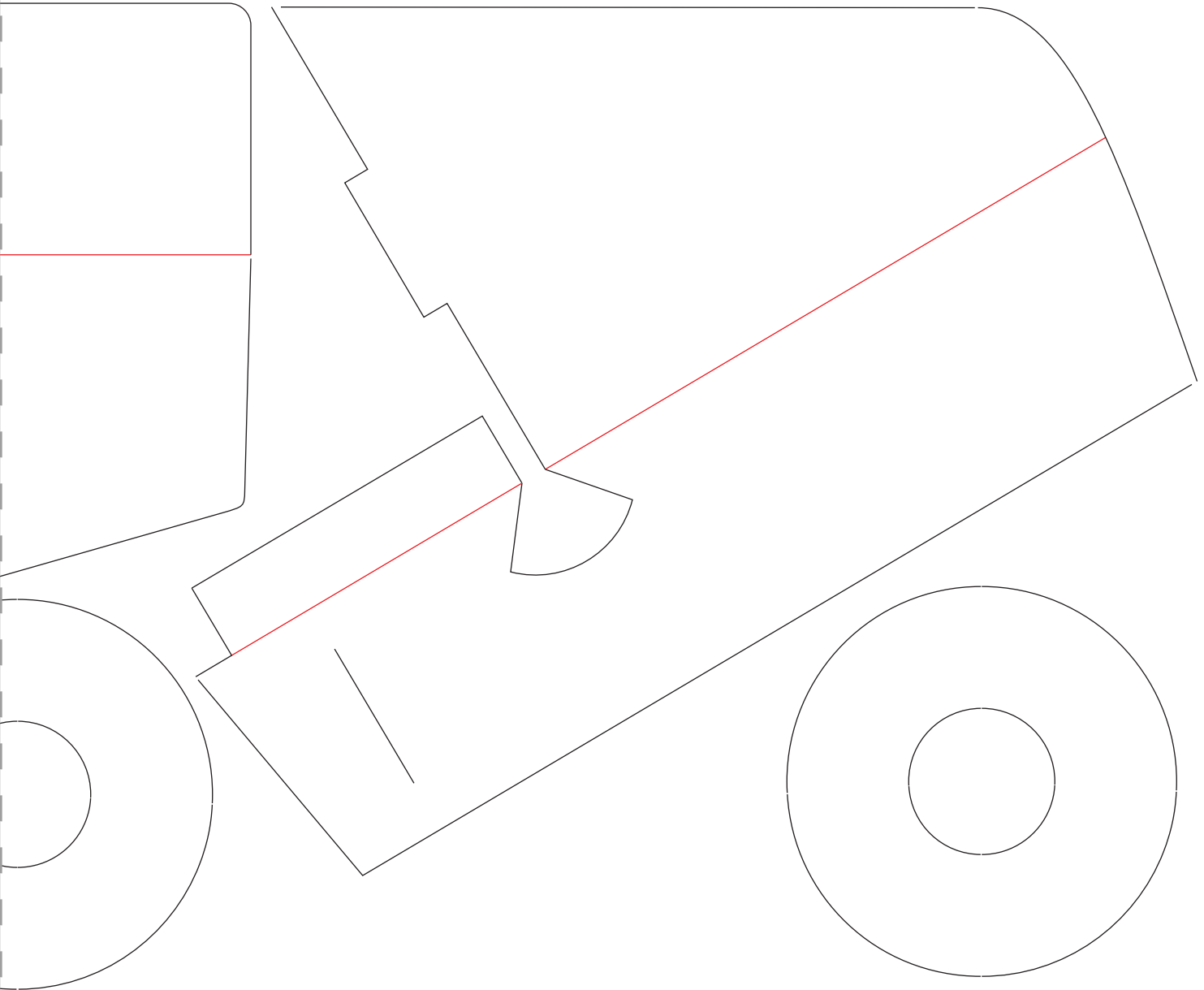
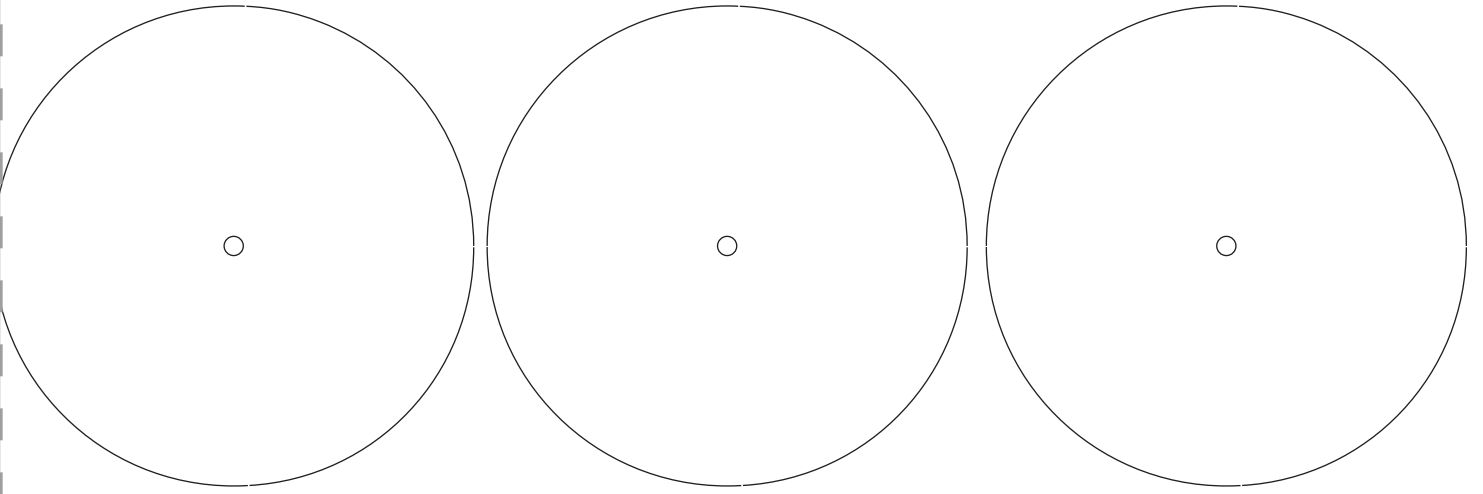

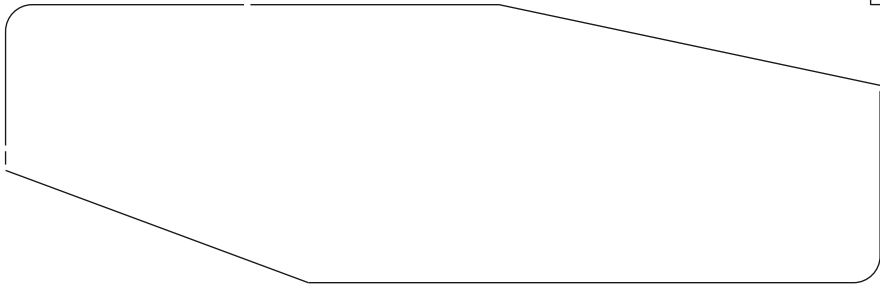
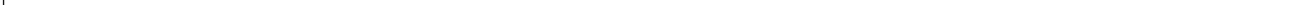
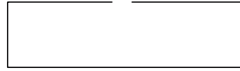

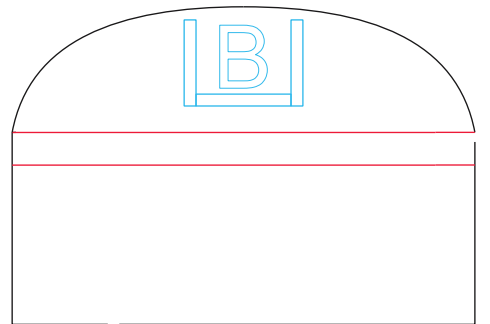
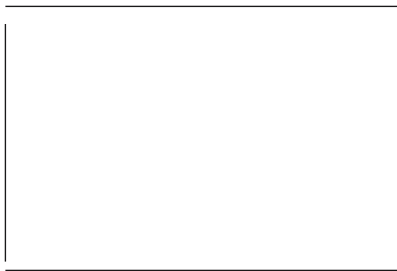

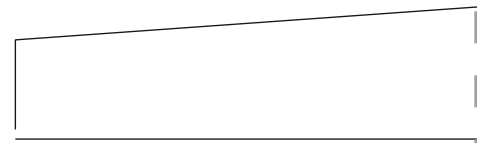
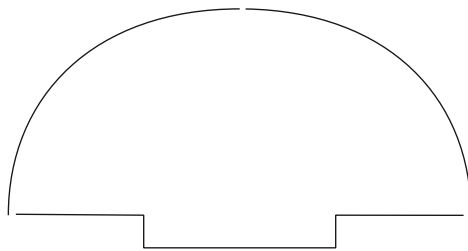
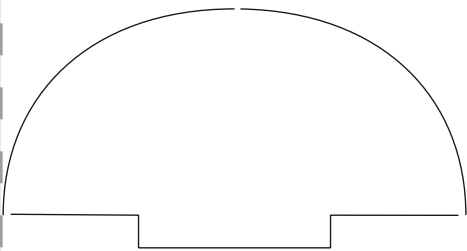

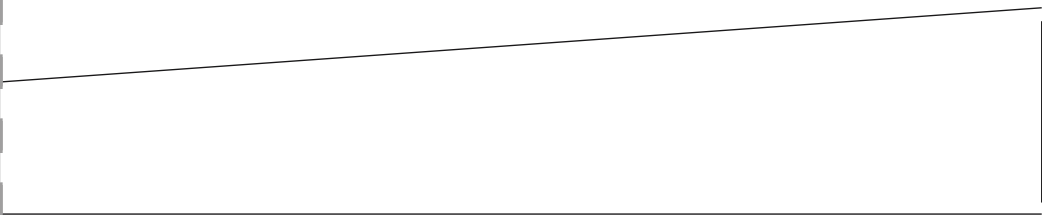
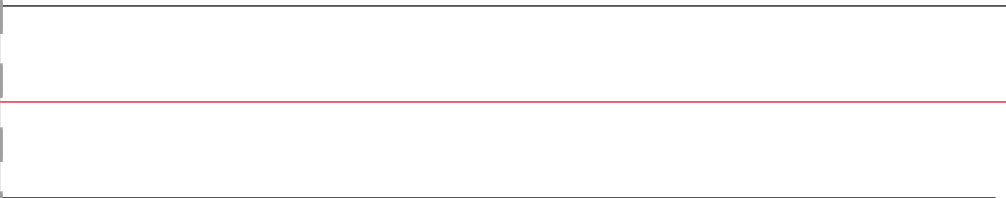



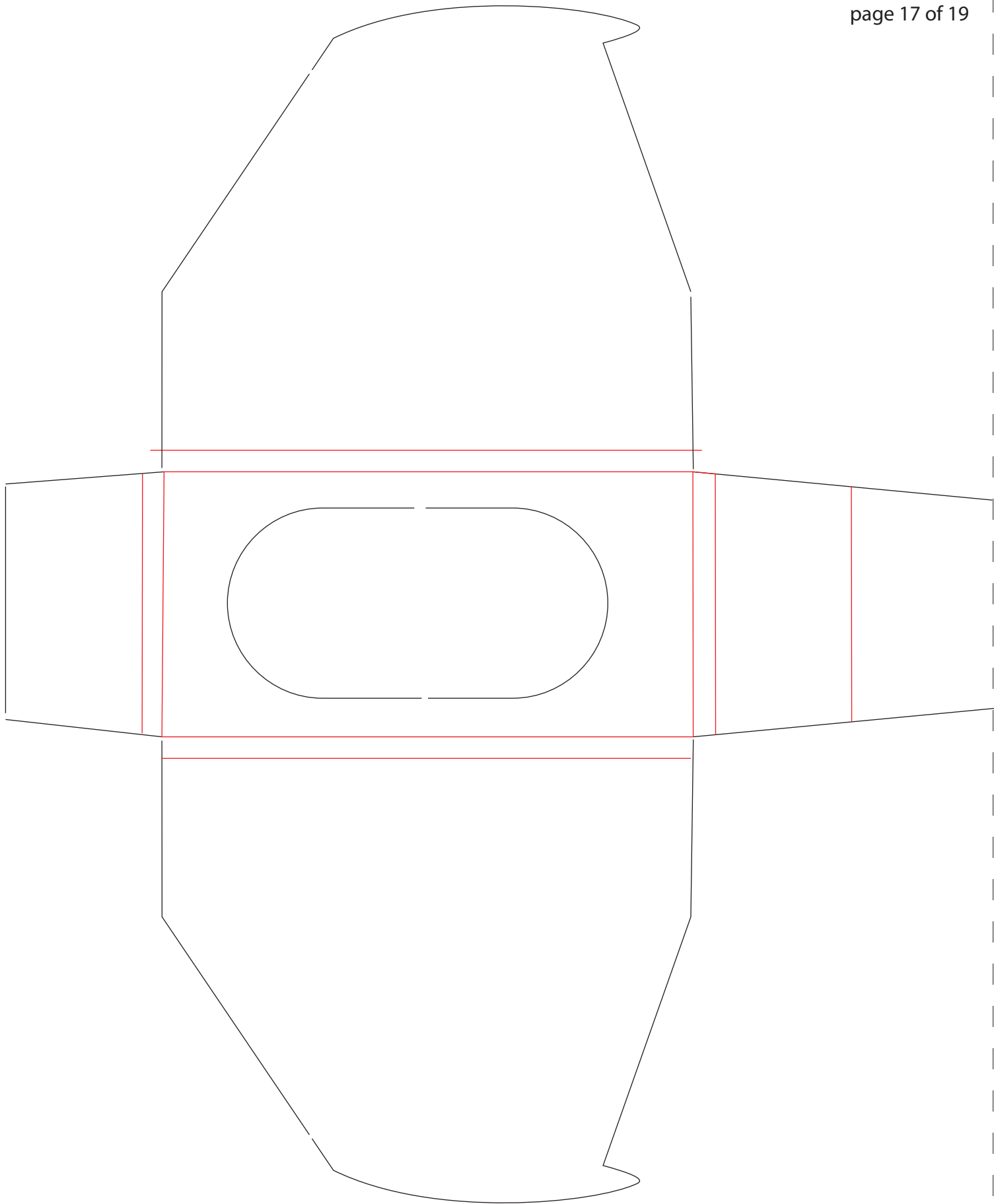

posterboard

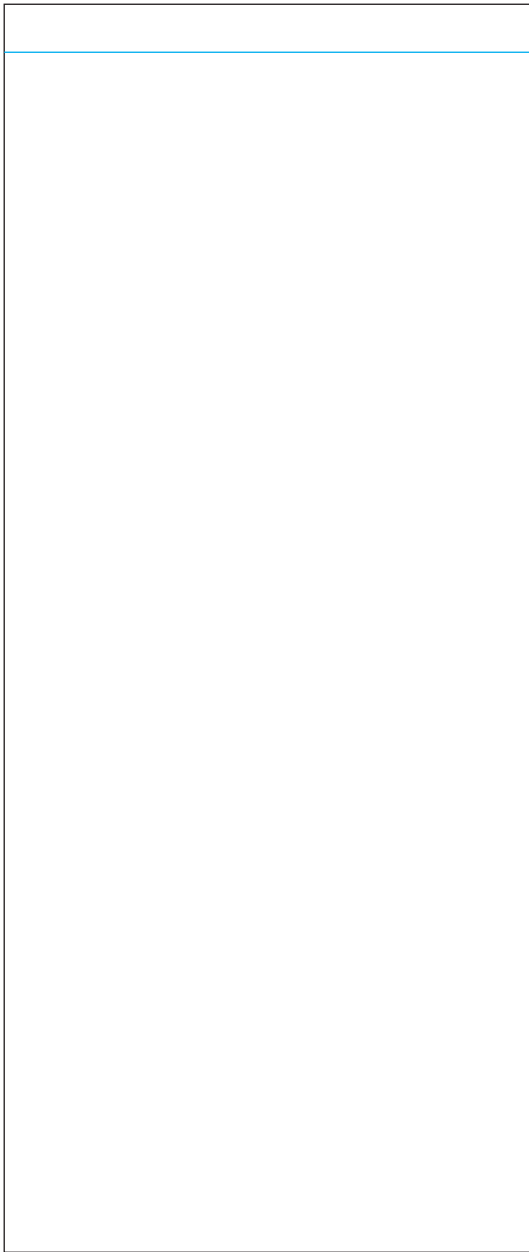

posterboard

# posterboard

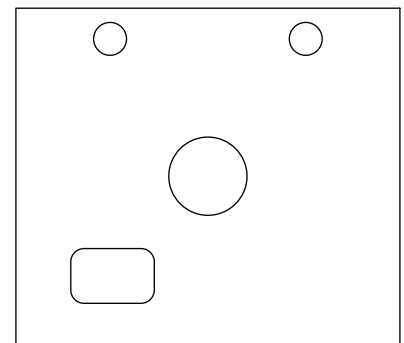
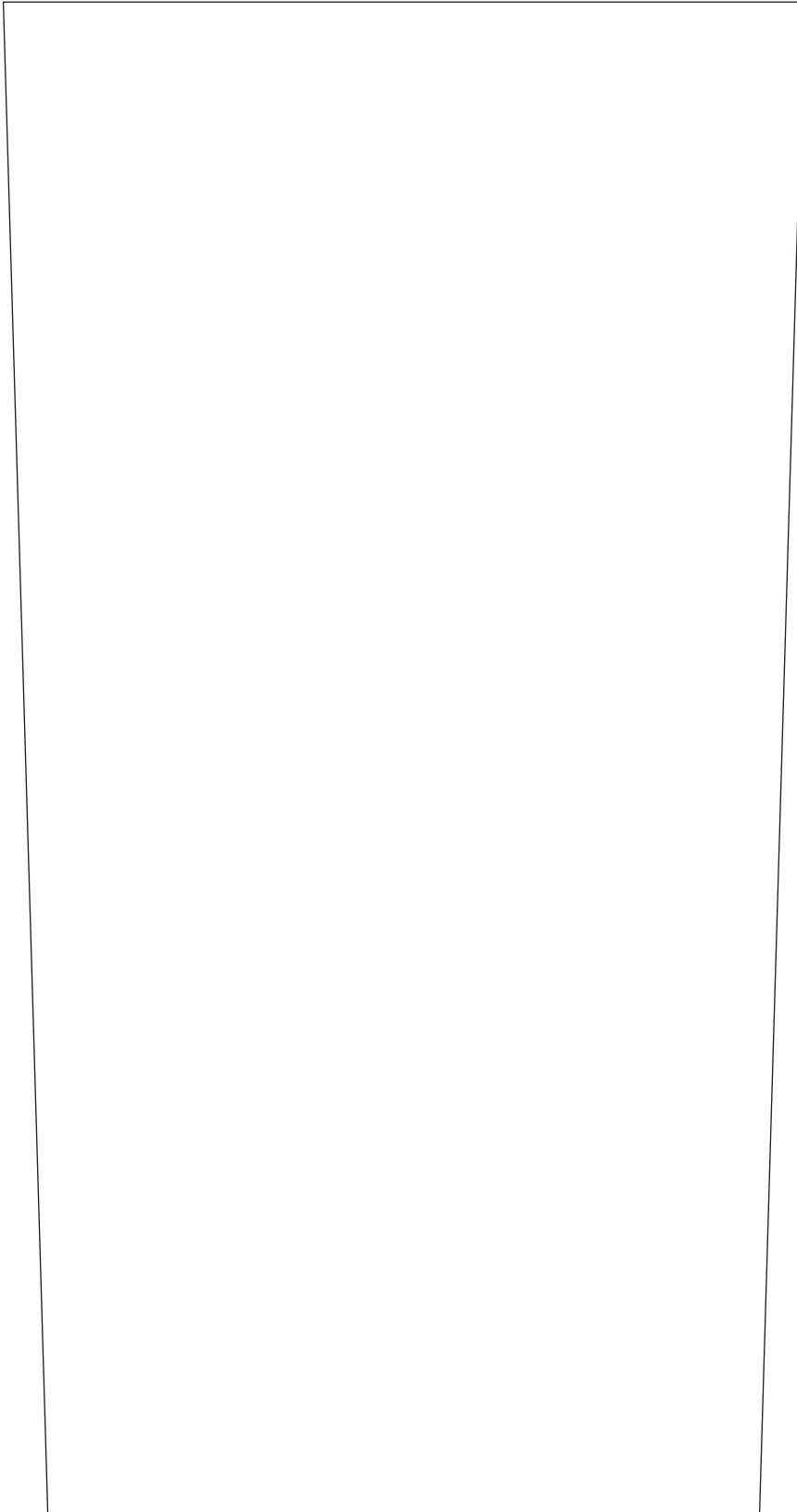

## Firewall

2" X 1 <sup>3</sup>/<sub>4</sub>" Inch  
(50mm X 45mm)

<sup>1</sup>/<sub>16</sub>" Inch thick  
(1.5mm)

Hobby Plywood